



TOSHIBA



DVD VIDEO PLAYER & VIDEO CASSETTE RECORDER SD-V396SU

OWNER'S MANUAL

VHS Hi-Fi SQPB

Introduction	2
Connections	14
Basic setup	22
Playback (VCR)	29
Recording (VCR)	34
Other functions (VCR)	39
Basic playback (DVD)	42
Advanced playback (DVD)	45
Function setup (DVD)	55
Others	67

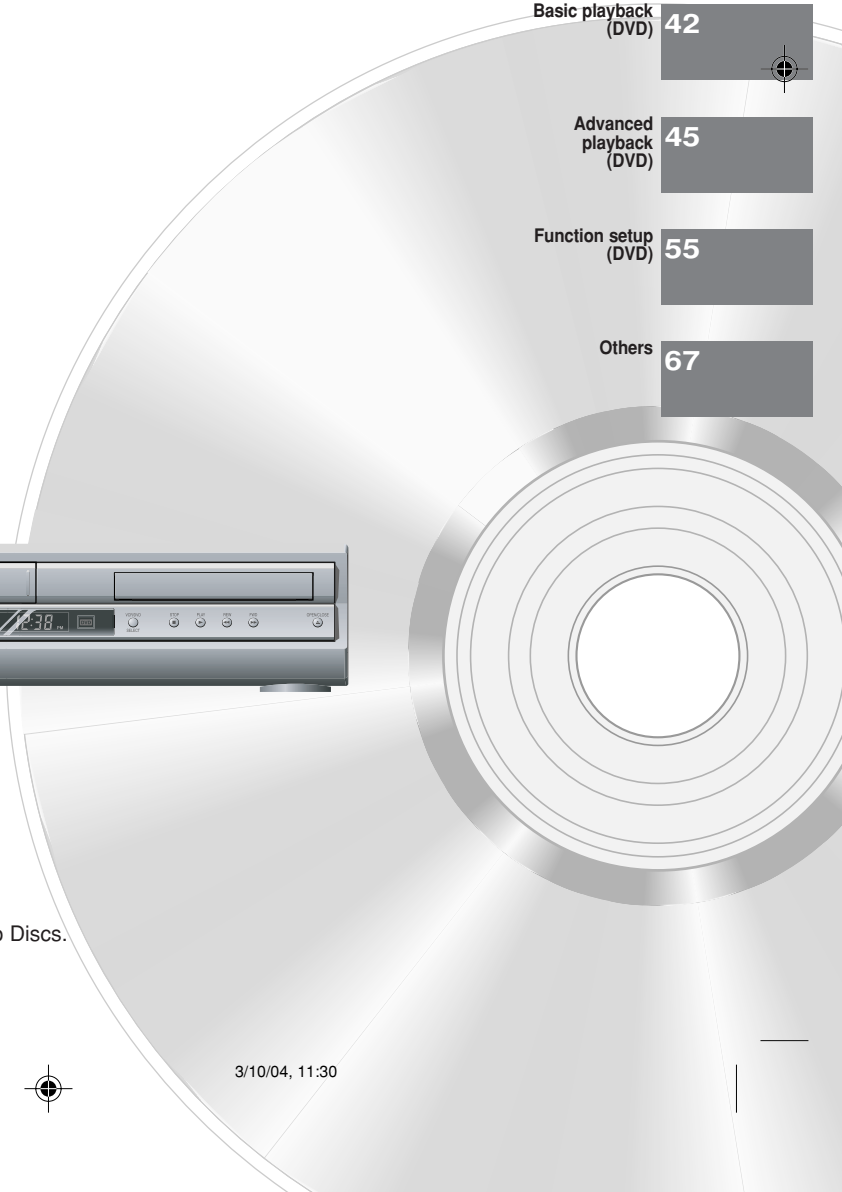

©2004 Toshiba Corporation
This device does not tape-record copy protected DVD Video Discs.



IMPORTANT SAFEGUARDS



The lightning flash with arrowhead symbol, within an equilateral triangle is intended to alert the user to the presence of uninsulated dangerous voltage within the product's enclosure that may be of sufficient magnitude to constitute a risk of electric shock to persons.



The exclamation point within an equilateral triangle is intended to alert the user to the presence of important operating and maintenance (servicing) instructions in the literature accompanying the appliance.

WARNING: TO REDUCE THE RISK OF FIRE OR ELECTRIC SHOCK, do not expose this appliance to rain or moisture.

CAUTION: TO PREVENT ELECTRIC SHOCK DO NOT USE THIS POLARIZED PLUG WITH AN EXTENSION CORD, RECEPTACLE OR OTHER OUTLET UNLESS THE BLADES CAN BE FULLY INSERTED TO PREVENT BLADE EXPOSURE.

WARNING: This equipment has been tested and found to comply with the limits for a Class B digital device, pursuant to Part 15 of the FCC Rules. These limits are designed to provide reasonable protection against harmful interference in a residential installation. This equipment generates, uses and can radiate radio frequency energy and, if not installed and used in accordance with the instructions, may cause harmful interference to radio communications.

However, there is no guarantee that interference will not occur in a particular installation. If this equipment does cause harmful interference to radio or television reception, which can be determined by turning the equipment off and on, the user is encouraged to try to correct the interference by one or more of the following measures:

- Reorient or relocate the receiving antenna.
- Increase the separation between the equipment and receiver.
- Connect the equipment into an outlet on a circuit different from that to which the receiver is connected.
- Consult the dealer or an experienced radio/TV technician for help.

CAUTION: Changes or modifications not expressly approved by the party responsible for compliance with the FCC Rules could void the user's authority to operate this equipment.

CAUTION: THIS DIGITAL VIDEO PLAYER EMPLOYS A LASER SYSTEM.

TO ENSURE PROPER USE OF THIS PRODUCT, PLEASE READ THIS USER'S GUIDE CAREFULLY AND RETAIN FOR FUTURE REFERENCE. SHOULD THE UNIT REQUIRE MAINTENANCE, CONTACT AN AUTHORIZED SERVICE LOCATION-SEE SERVICE PROCEDURE.

USE OF CONTROLS, ADJUSTMENTS OR THE PERFORMANCE OF PROCEDURES OTHER THAN THOSE SPECIFIED HEREIN MAY RESULT IN HAZARDOUS RADIATION EXPOSURE.

TO PREVENT DIRECT EXPOSURE TO LASER BEAM, DO NOT TRY TO OPEN THE ENCLOSURE. VISIBLE LASER RADIATION MAY BE PRESENT WHEN THE ENCLOSURE IS OPENED. DO NOT STARE INTO BEAM.

Location of the required Marking

The rating sheet and the safety caution are on the rear of the unit.

CERTIFICATION: COMPLIES WITH FDA RADIATION PERFORMANCE STANDARDS, 21 CFR SUBCHAPTER J.

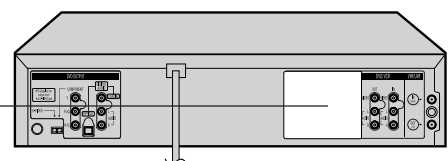



IMPORTANT SAFEGUARDS

1. READ INSTRUCTIONS

All the safety and operating instructions should be read before the unit is operated.

2. RETAIN INSTRUCTIONS

The safety and operating instructions should be retained for future reference.

3. HEED WARNINGS

All warnings on the unit and in the operating instructions should be adhered to.

4. FOLLOW INSTRUCTIONS

All operating and use instructions should be followed.

5. CLEANING

Unplug this unit from the wall outlet before cleaning. Do not use liquid cleaners or aerosol cleaners.

Use a damp cloth for cleaning the exterior cabinet only.

6. ATTACHMENTS

The manufacturer of this unit does not make any recommendations for attachments, as they may cause hazards.

7. WATER AND MOISTURE

Do not use this unit near water. For example, near a bathtub, washbowl, kitchen sink, laundry tub, in a wet basement, or near a swimming pool.

8. ACCESSORIES

Do not place this unit on an unstable cart, stand, tripod, bracket, or table.

The unit may fall, causing serious injury, and serious damage to the unit.

- 8A.** An appliance and cart combination should be moved with care. Quick stops, excessive force, and uneven surfaces may cause the appliance and cart combination to overturn.

9. VENTILATION

Slots and openings in the cabinet back or bottom are provided for ventilation, to ensure reliable operation of the unit, and to protect it from overheating.

These openings must not be blocked or covered. The openings should never be blocked by placing the unit on a bed, sofa, rug, or other similar surface. This unit should never be placed near or over a radiator or heat source. This unit should not be placed in a built-in installation such as a bookcase or rack unless proper ventilation is provided and/or the manufacturer's instructions have been adhered to.

10. POWER SOURCE

This unit should be operated only from the type of power source indicated on the rating plate. If you are not sure of the type of power supply to your home, consult your appliance dealer or local power company. For units intended to operate from battery power, or other sources, refer to the operating instructions.

11. GROUNDING OR POLARIZATION

This unit is equipped with a polarized alternating-current line plug (a plug having one blade wider than the other). This plug will fit into the power outlet only one way. This is a safety feature. If you are unable to insert the plug fully into the outlet, try reversing the plug. If the plug should still fail to fit, contact your electrician to replace your obsolete outlet. Instead of the polarized alternating-current line plug, your unit may be equipped with a 3-wire grounding-type plug (a plug having a third (grounding) pin). This plug will only fit into a grounding-type power outlet. This too, is a safety feature. If you are unable to insert the plug into the outlet, contact your electrician to replace your obsolete outlet. Do not defeat the safety purpose of the grounding-type plug.

12. POWER-CORD PROTECTION

Power-supply cords should be routed so that they are not likely to be walked on or pinched by items placed upon or against them, paying particular attention to cords at plugs, convenience receptacles, and the point where they exit from the appliance.

PORTABLE CART WARNING
(symbol provided by RETAC)



S3125A

IMPORTANT SAFEGUARDS

13. LIGHTNING

To protect your unit from a lightning storm, or when it is left unattended and unused for long periods of time, unplug it from the wall outlet and disconnect the antenna or cable system. This will prevent damage to the unit due to lightning and power line surges.

14. POWER LINES

An outside antenna system should not be located in the vicinity of overhead power lines or other electric light or power circuits, or where it can fall onto or against such power lines or circuits. When installing an outside antenna system, extreme care should be taken to keep from touching such power lines or circuits, as contact with them might be fatal.

15. OVERLOADING

Do not overload wall outlets and extension cords, as this can result in a risk of fire or electric shock.

16. OBJECT AND LIQUID ENTRY

Do not push objects through any openings in this unit, as they may touch dangerous voltage points or short out parts that could result in fire or electric shock. Never spill or spray any type of liquid into the unit.

17. OUTDOOR ANTENNA GROUNDING

If an outside antenna or cable system is connected to the unit, be sure the antenna or cable system is grounded to provide some protection against voltage surges and built-up static charges, Section 810 of the National Electrical Code, ANSI/NFPA 70, provides information with respect to proper grounding of the mast and supporting structure, grounding of the lead-in wire to an antenna discharge unit, size of grounding conductors, location of antenna discharge unit, connection to grounding electrodes, and requirements for the grounding electrode.

18. SERVICING

Do not attempt to service this unit yourself as opening or removing covers may expose you to dangerous voltage or other hazards. Refer all servicing to qualified service personnel.

For example:

- a. When the power-supply cord or plug is damaged.
- b. If liquid has been spilled, or objects have fallen into the unit.
- c. If the unit has been exposed to rain or water.
- d. If the unit does not operate normally by following the operating instructions. Adjust only those controls that are covered by the operating instructions, as an improper adjustment of other controls may result in damage and will often require extensive work by a qualified technician to restore the unit to its normal operation.
- e. If the unit has been dropped or the cabinet has been damaged.
- f. When the unit exhibits a distinct change in performance, this indicates a need for service.

19. REPLACEMENT PARTS

When replacement parts are required, be sure the service technician uses replacement parts specified by the manufacturer or those that have the same characteristics as the original part.

Unauthorized substitutions may result in fire, electric shock or other hazards.

20. SAFETY CHECK

Upon completion of any service or repairs to this unit, ask the service technician to perform safety checks to determine that the unit is in proper operating condition.

21. HEAT

The product should be situated away from heat sources such as radiators, heat registers, stoves, or other products (including amplifiers) that produce heat.

22. DISC TRAY

Keep your fingers well clear of the disc tray as it is closing. It may cause serious personal injury.

23. CONNECTING

When you connect the product to other equipment, turn off the power and unplug all of the equipment from the wall outlet. Failure to do so may cause an electric shock and serious personal injury. Read the owner's manual of the other equipment carefully and follow the instructions when making any connections.



IMPORTANT SAFEGUARDS / Power source

24. LASER BEAM

Do not look into the opening of the disc tray or ventilation opening of the product to see the source of the laser beam. It may cause sight damage.

25. DISC

Do not use a cracked, deformed, or repaired disc. These discs are easily broken and may cause serious personal injury and product malfunction.

26. NOTE TO CATV SYSTEM INSTALLER

This reminder is provided to call the CATV system installer's attention to Article 820-40 of the NEC that provides guidelines for proper grounding and, in particular, specifies that the cable ground shall be connected to the grounding system of the building, as close to the point of cable entry as practical.

EXAMPLE OF ANTENNA GROUNDING AS PER THE NATIONAL ELECTRICAL CODE

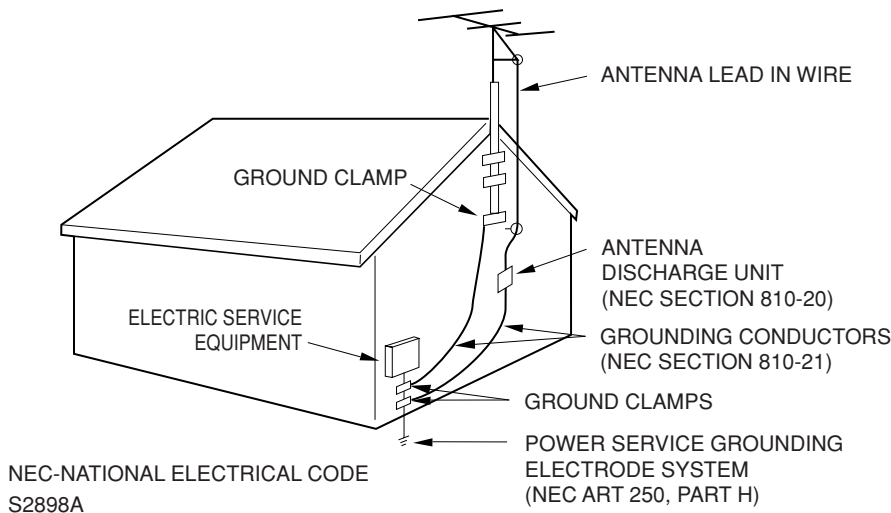

Power source

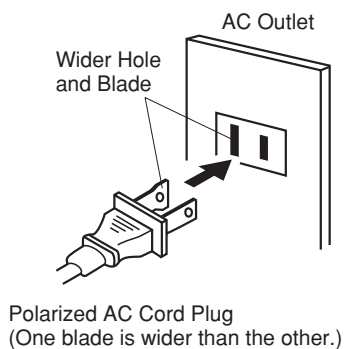

TO USE AC POWER SOURCE

Use the AC polarized line cord provided for operation on AC. Insert the AC cord plug into a standard 120V 60Hz polarized AC outlet.

Notes:

- Never connect the AC line cord plug to other than the specified voltage (120V 60Hz). Use the attached power cord only.
- If the polarized AC cord does not fit into a non-polarized AC outlet, do not attempt to file or cut the blade. It is the user's responsibility to have an electrician replace the obsolete outlet.
- If you cause a static discharge when touching the unit and the unit fails to function, simply unplug the unit from the AC outlet and plug it back in. The unit should return to normal operation.



Precautions

Notes on handling

- When shipping the DVD/VCR, the original shipping carton and packing materials come in handy. For maximum protection, repack the unit as it was originally packed at the factory.
- Do not use volatile liquids, such as insect spray, near the DVD/VCR. Do not leave rubber or plastic products to contact the DVD/VCR for a prolonged period. They will leave marks on the finish.
- The top and rear panels of the DVD/VCR may become warm after a long period of use. This is not a malfunction.
- When the DVD/VCR is not in use, be sure to remove the disc and the video cassette turn off the power.
- If you do not use the DVD/VCR for a long period, the unit may not function properly in the future. Turn on and use the DVD/VCR occasionally.

Notes on locating

- Place the DVD/VCR on a level surface. Do not use it on a shaky or unstable surface such as a wobbling table or inclined stand. The loaded disc or the video tape may become dis-aligned and damage the DVD/VCR.
- When you place this DVD/VCR near a TV, radio, or VCR, the playback picture may become poor and the sound may be distorted. In this case, place the DVD/VCR away from the TV, radio, or VCR.

Notes on cleaning

Use a soft, dry cloth for cleaning.

- For stubborn dirt, soak the cloth in a weak detergent solution, wring well and wipe. Use a dry cloth to wipe it dry.
Do not use any type of solvent, such as thinner and benzene, as they may damage the surface of the DVD/VCR.
- If you use a chemical saturated cloth to clean the unit, follow that product's instructions.

To obtain a clear picture

The DVD/VCR is a high technology, precision device. If the video head, the head drum, the optical pick-up lens or disc drive parts are dirty or worn down, the picture quality will deteriorate. To obtain a clear picture, we recommend regular inspection and maintenance (cleaning or parts replacement) every 1,000 hours of use depending on the operating environment. For details, contact your nearest dealer.

Notes on moisture condensation

Moisture condensation damages the DVD/VCR. Please read the following carefully.

Moisture condensation occurs, for example, when you pour a cold drink into a glass on a warm day. Drops of water form on the outside of the glass. In the same way, moisture may condense on the head drum or the optical pick-up lens inside this unit, one of the most crucial internal parts of the DVD/VCR.

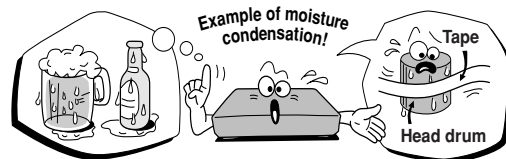

■ **Moisture condensation occurs during the following cases.**

- When you bring the DVD/VCR directly from a cold place to a warm place.
- When you use the DVD/VCR in a room where you just turned on the heater, or a place where the cold wind from the air conditioner directly hits the unit.
- In summer, when you use the DVD/VCR in a hot and humid place just after you move the unit from an air conditioned room.
- When you use the DVD/VCR in a humid place.

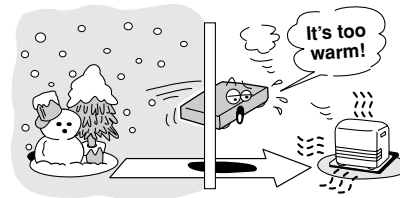

■ **Do not use the DVD/VCR when moisture condensation may occur.**

If you use the DVD/VCR in such a situation, it may damage discs and internal parts. Remove the disc or the video tape, connect the power cord of the DVD/VCR to the wall outlet, turn on the DVD/VCR, and leave it for two or three hours. After two or three hours, the DVD/VCR will have warmed up and evaporated any moisture. Keep the DVD/VCR connected to the wall outlet and moisture condensation will seldom occur.

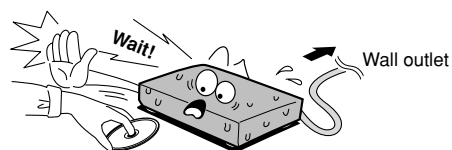



Notes on discs

On handling discs

- Do not touch the playback side of the disc.

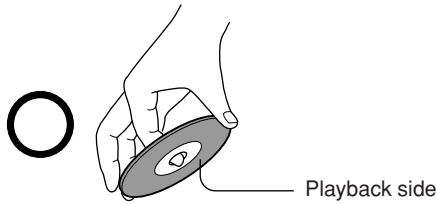

- Do not attach paper or tape to discs.



On cleaning discs

- Fingerprints and dust on the disc cause picture and sound deterioration. Wipe the disc from the center outwards with a soft cloth. Always keep the disc clean.

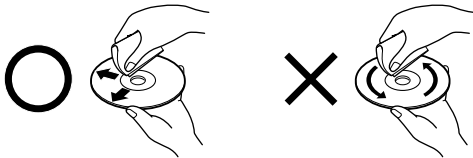

- If you cannot wipe off the dust with a soft cloth, wipe the disc lightly with a slightly moistened soft cloth and finish with a dry cloth.
- Do not use any type of solvent such as thinner, benzine, commercially available cleaners or antistatic spray for vinyl LPs. It may damage the disc.

On storing discs

- Do not store discs in a place subject to direct sunlight or near heat sources.
- Do not store discs in places subject to moisture and dust such as a bathroom or near a humidifier.
- Store discs vertically in a case. Stacking or placing objects on discs outside of their case may cause warping.

Structure of disc contents

Normally, DVD video discs are divided into titles, and the titles are sub-divided into chapters. VIDEO CDs and audio CDs are divided into tracks.

DVD video disc

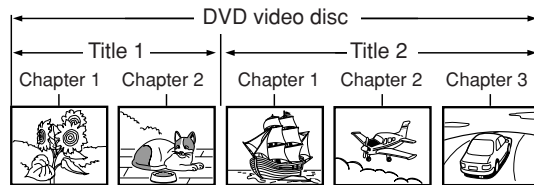

Video CD/Audio CD

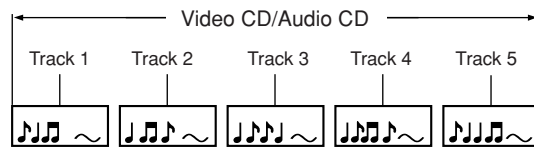

Each title, chapter or track is assigned a number, which is called "title number", "chapter number" or "track number" respectively.

There may be discs that do not have these numbers.

Notes on copyright

It is forbidden by law to copy, broadcast, show, broadcast on cable, play in public, and rent copyrighted material without permission.

This device does not tape-record copy protected DVD Video Discs.

The device is not to be used for copying copyrighted content without the express written permission of the copyright owner.

Obtaining such permission is the sole responsibility of the user.



This product incorporates copyright protection technology that is protected by method claims of certain U.S. patents and other intellectual property rights owned by Macrovision Corporation and other rights owners. Use of this copyright protection technology must be authorized by Macrovision Corporation, and is intended for home and other limited viewing uses only unless otherwise authorized by Macrovision Corporation. Reverse engineering or disassembly is prohibited.





Notes on discs (continued)

About this owner's manual

This owner's manual explains the basic instructions of this DVD/VCR. Some DVD video discs are produced in a manner that allows specific or limited operation during playback. As such, the DVD/VCR may not respond to all operating commands. This is not a defect in the DVD/VCR. Refer to instruction notes of discs.

“” may appear on the TV screen during operation. A “” means that the operation is not permitted by the DVD/VCR or the disc. For example, sometimes it is unable to stop the playback of copyright message of the disc when the STOP (■) button is pressed. Alternatively, the “” may also indicate that the feature is not available for the disc.

Notes on region numbers

The region number of this DVD/VCR is 1. If region numbers, which stand for their playable area, are printed on your DVD video disc and you do not find  or , disc playback will not be allowed by the player. (In this case, the DVD/VCR will display a message on-screen.)

On Video CDs

This DVD/VCR supports Video CDs equipped with the PBC (Version 2.0) function. (PBC is the abbreviation of Playback Control.) You can enjoy two playback variations depending on types of discs.

- **Video CD not equipped with PBC function (Version 1.1)**
Sound and movie can be played on this DVD/VCR in the same way as an audio CD.
- **Video CD equipped with PBC function (Version 2.0)**
In addition to operation of a Video CD not equipped with the PBC function, you can enjoy playback of interactive software with search function by using the menu displayed on the TV screen (Menu Playback). Some of the functions described in this owner's manual may not work with some discs.

Playable discs

This DVD/VCR can play the following discs.

	Disc Mark	Contents	Disc Size	Maximum playback time
DVD video discs		Audio + Video (moving pictures)	12 cm	Approx. 4 hours (single sided disc)
				Approx. 8 hours (double sided disc)
			8 cm	Approx. 80 minutes (single sided disc)
				Approx. 160 minutes (double sided disc)
Video CDs		Audio + Video (moving pictures)	12 cm	Approx. 74 minutes
			8 cm	Approx. 20 minutes
Audio CDs		Audio	12 cm	Approx. 74 minutes
			8 cm (CD single)	Approx. 20 minutes

The following discs are also available.

- DVD-R/RW discs of DVD video format
 - CD-R/CD-RW discs of CD-DA, Video CD, SVCD, MP3, WMA or JPEG format
 - Kodak Picture CD and FUJICOLOR CD format
- Some of these discs may be incompatible.

- You cannot play discs other than those listed above.
- You cannot play discs of DVD-RAM, DVD-ROM, Photo CD, etc., or non standardized discs even if they may be labeled as above.
- Some CD-R/RWs can not be played back depending on the recording conditions.
- This DVD/VCR uses the NTSC color system, and cannot play DVD video discs recorded in any other color system (PAL, SECAM, etc.).



Contents

Introduction

IMPORTANT SAFEGUARDS	2
Power source	5
Precautions	6
Notes on discs	7
Contents	9
Identification of controls	10

Connections

Antenna connections	14
CATV (CABLE TV) connections	16
Connecting to a TV	18
Connecting to optional equipment	20

Basic setup

Setting the video channel	22
Setting the language	23
Clock setting	24
Tuner setting	27

Playback (VCR)

Loading and unloading a cassette tape	29
Cassette tape playback	30
Special playback	31
Convenience function	32

Recording (VCR)

Recording a TV program	34
One-touch Timer Recording (OTR)	36
Timer recording	37

Other functions (VCR)

Stereo recording and playback	39
Second Audio Program (SAP)	39
Duplicating a video tape	40
Recording a DVD/CD disc	41

Basic playback (DVD)

Playing a disc	42
----------------------	----

Advanced playback (DVD)

MP3/WMA/JPEG playback	45
Zooming	50
Locating desired scene	50
Marking desired scenes	51
Repeat playback	52
A-B Repeat playback	52
Program playback (CD)	53
Random playback (CD)	53
Changing angles	54
Title selection	54
DVD menu	54

Function setup (DVD)

Changing soundtrack language	55
Setting surround sound	55
Setting subtitles	56
Karaoke playback	56
E.B.L. (Enhanced Black Level)	57
Setting the aspect ratio of TV screen	58
Setting on screen display	59
Status display of disc	59
Dynamic Range Control	60
Parental control setting	61
To change the parental level	62
Temporary disabling of rating level by DVD disc ..	63
Setting OSD language	64
Setting language	65
Selecting PROGRESSIVE scan	66

Others

Language code list	67
Troubleshooting	68
Specifications	69
Limited warranty	70

Introduction



Identification of controls

See the page in for details.

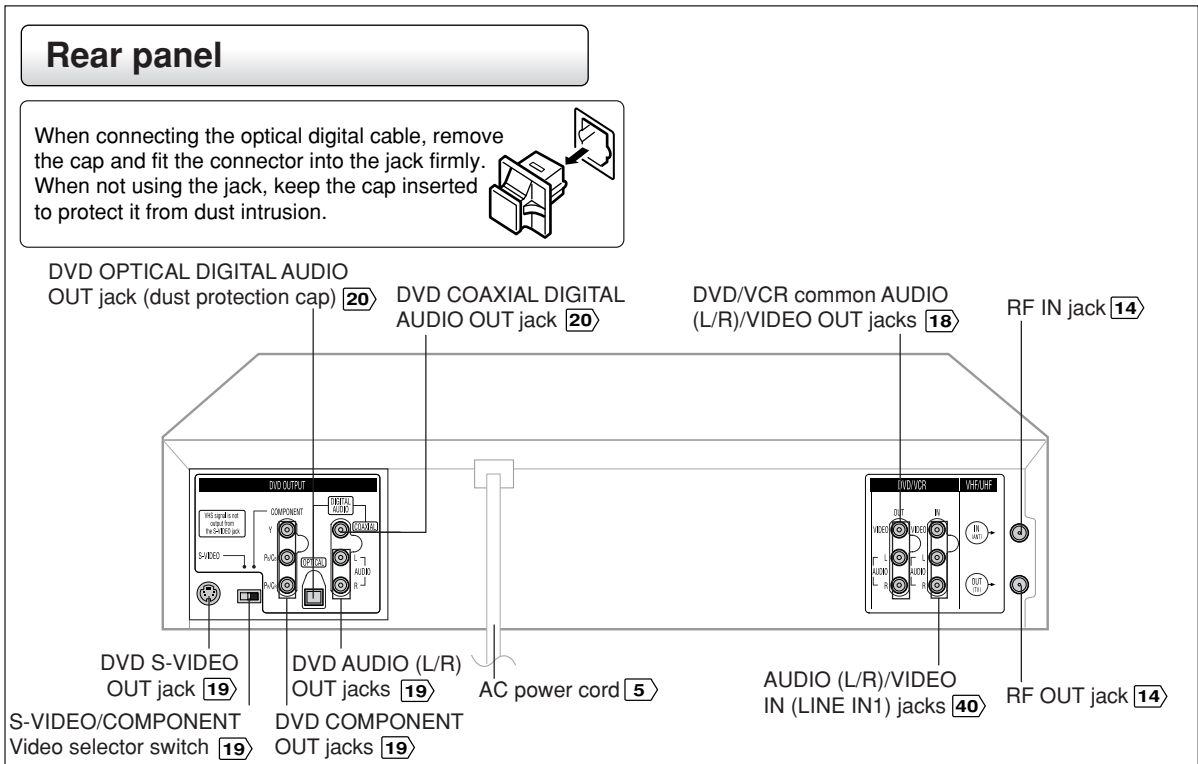
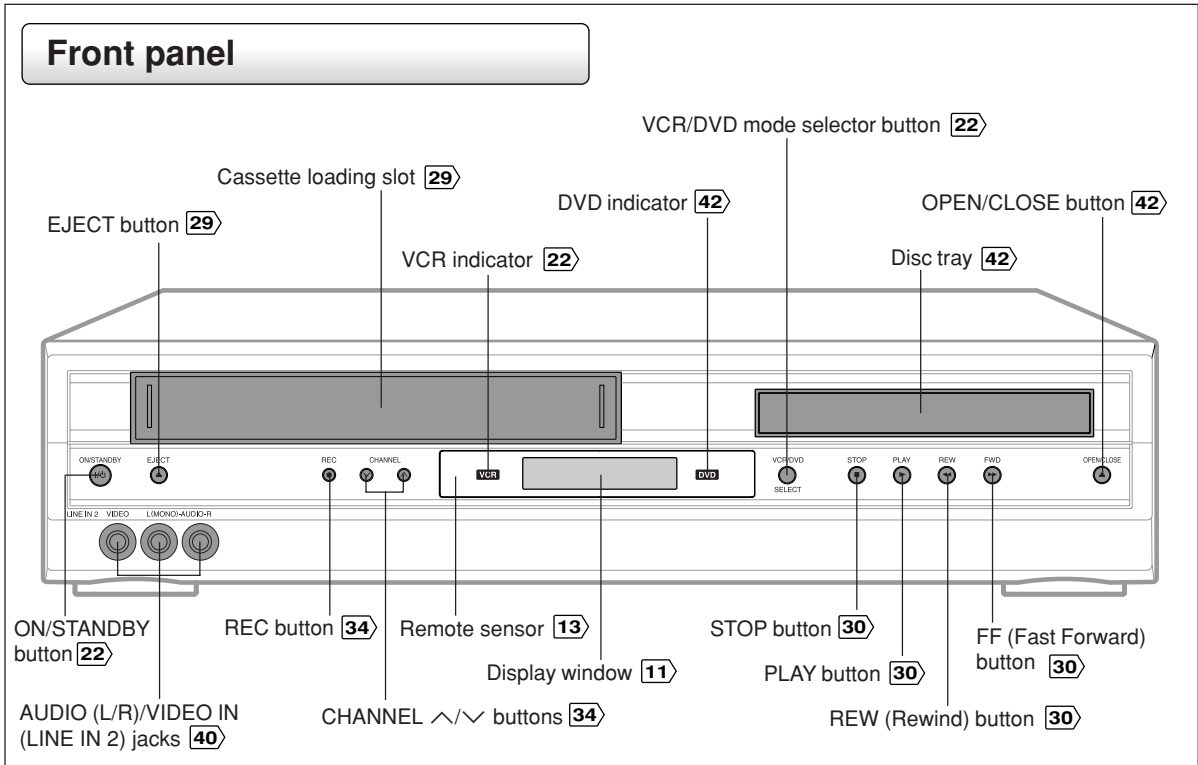



Display window

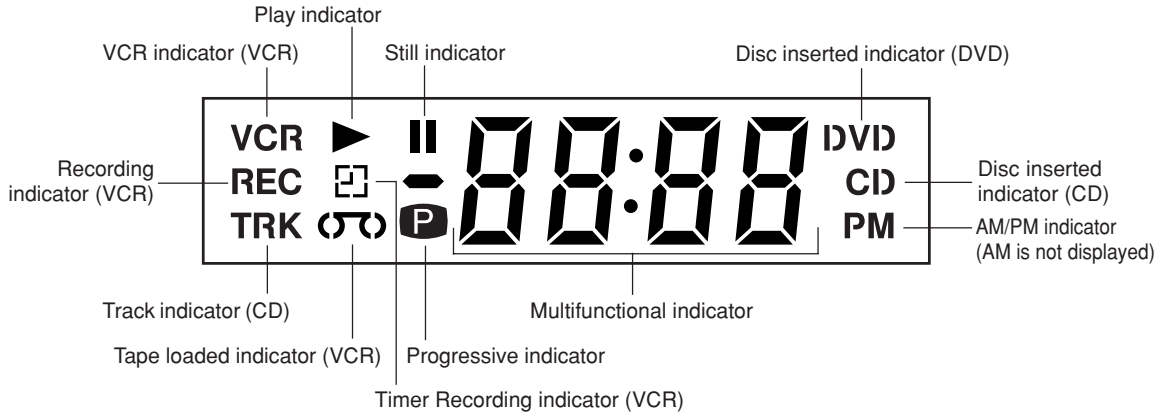

VCR operation status

Press **CALL** to display information on screen.
To cancel the display, press **CALL** again.

While watching TV

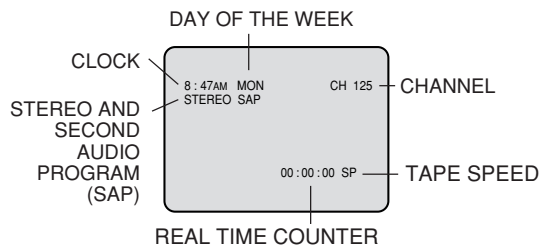

While operating a tape

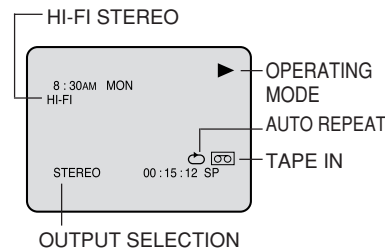

VCR Icons

- Recording : ●
- Rec/Pause : ●||
- Play : ▶
- Stop : ■
- Eject : ▲

DVD/CD/VCD operation status

Each press of **DISPLAY**, the status display of the disc will appear on the screen and change as follows.

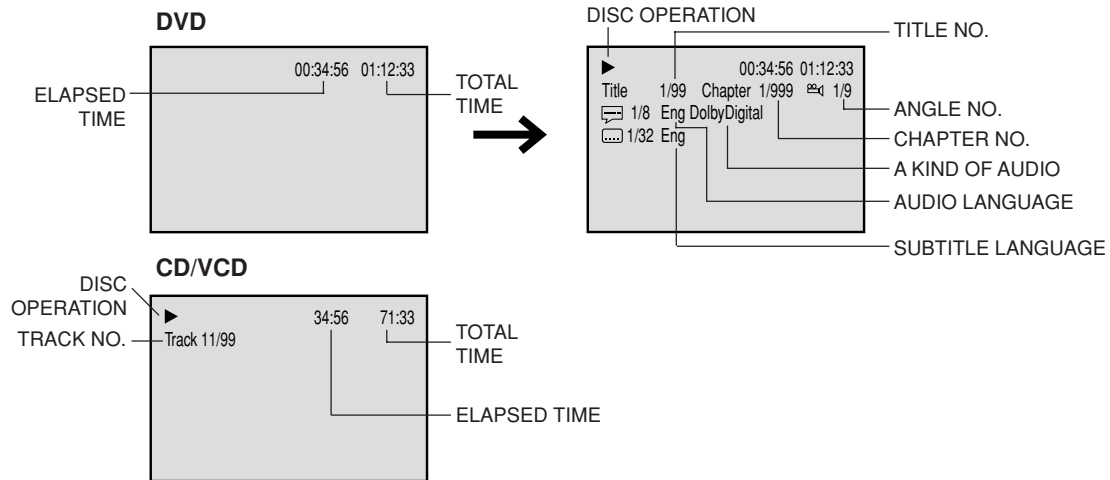

Identification of Controls (continued)

The instructions in this manual describe the functions on the remote control. See the page in  for details.

Remote control

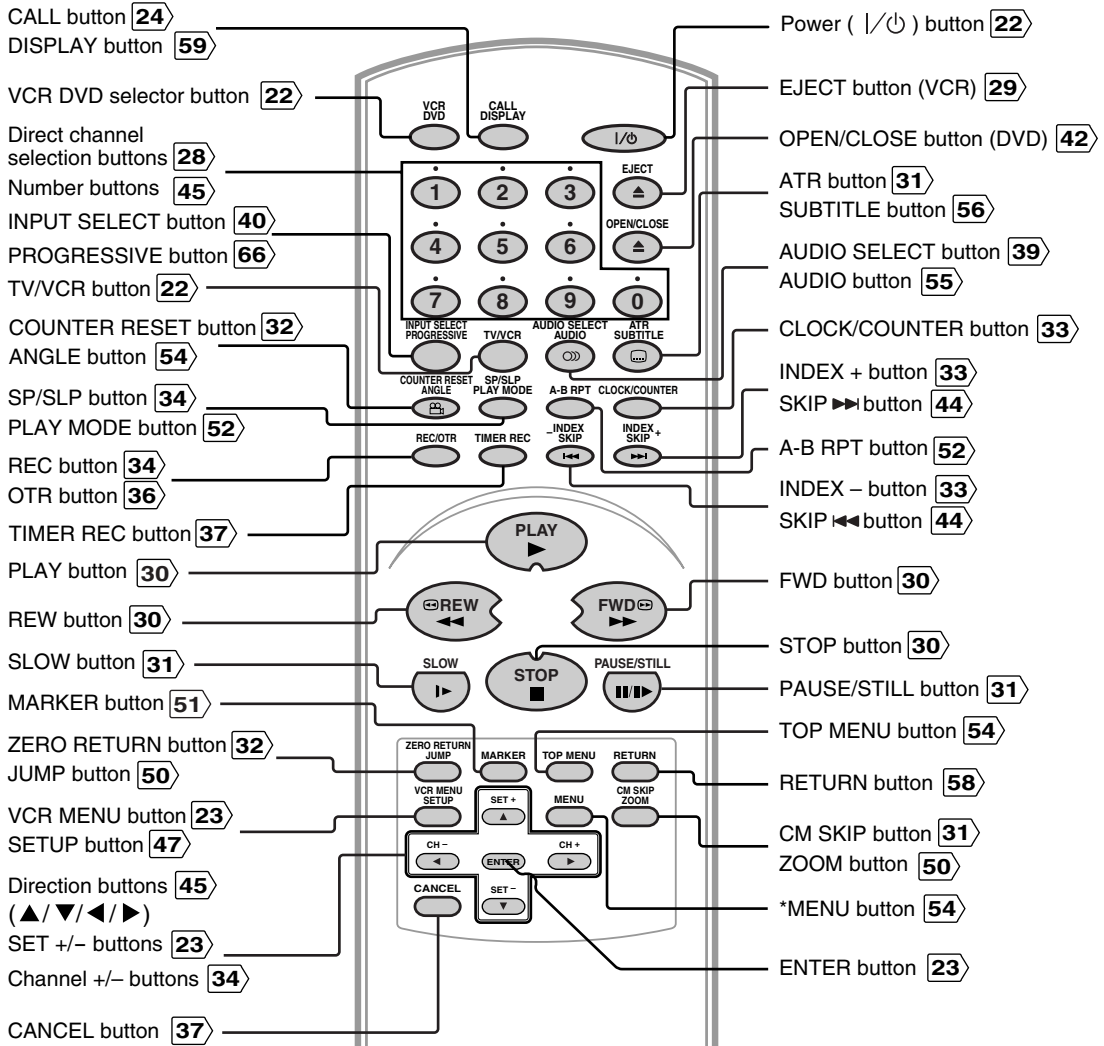

*** MENU button**

Use the MENU button to display the menu included on many DVD video discs. To operate a menu, follow the instructions in "DVD Menu." **54**



Inserting batteries

- 1** Slide the battery compartment cover in the direction of the arrow.

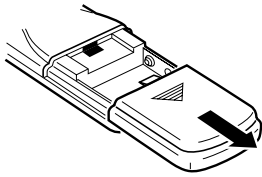

- 2** Install two "R03/AAA" batteries (supplied), paying attention to the polarity diagram in the battery compartment.

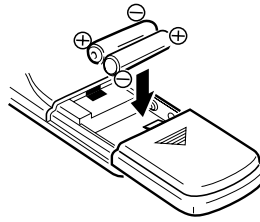

- 3** Replace the compartment cover.

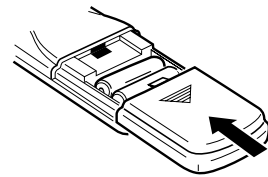

Battery precautions

The precautions below should be followed when using batteries in this device:

1. Use only the size and type of batteries specified.
2. Be sure to follow the correct polarity when installing the batteries as indicated in the battery compartment. Reversed batteries may cause damage to the device. To avoid a potential short circuit, insert the "-" end first.
3. Do not mix different types of batteries together (e.g. Alkaline and Carbon-zinc) or old batteries with fresh ones.
4. If the device is not to be used for a long period of time, remove the batteries to prevent damage or injury from possible battery leakage.
5. Do not try to recharge batteries not intended to be recharged; they can overheat and rupture. (Follow battery manufacturer's directions.)

Remote control basics

- Press **POWER** (I/O) to turn the DVD VCR on or off.
- Select your desired operating mode (DVD or VCR) using **VCR DVD**. (DVD or VCR indicator on the front panel will show you which mode is selected.)
- Press **CH +** or **CH -** to move through the channels one channel at a time.
- The **CH +/-** (◀/▶) and **SET +/-** (▲/▼) are also used to navigate on-screen menu system.
- You can directly access specific channels using **Number buttons**.
- Each press of **VCR DVD** on the remote control, switches the screen between the VCR screen (VCR mode) and the DVD screen (DVD mode).

Operation

- Aim the remote control at the remote sensor and press control buttons to operate.
- Operate the remote control within 30° angle on either side of the remote sensor, up to a distance of Approx. 7 meters.

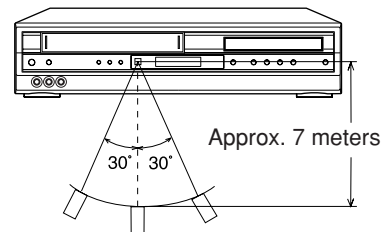

Antenna connections

If you are using an antenna system, follow these instructions. If you are a cable (CATV) subscriber, skip ahead to page 16 for the proper connections.

Antenna to DVD/VCR connection

The DVD/VCR must be connected “between” the antenna and the TV. First, disconnect the antenna from the TV and connect it to the DVD/VCR. Then connect the DVD/VCR to the TV. Below are 3 common methods of connecting an antenna system to a DVD/VCR. Find the type of antenna system you are using and follow the connection diagram.

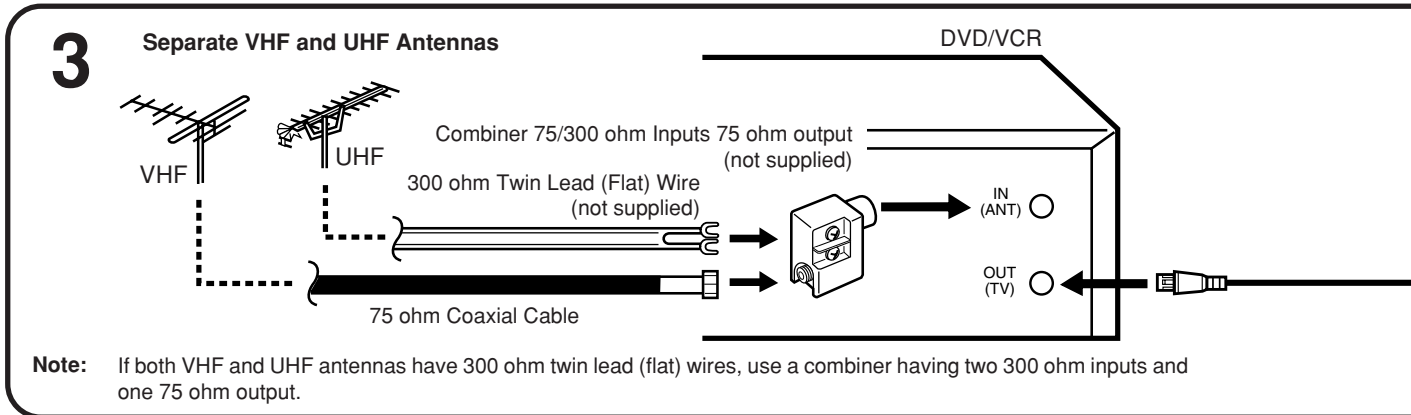
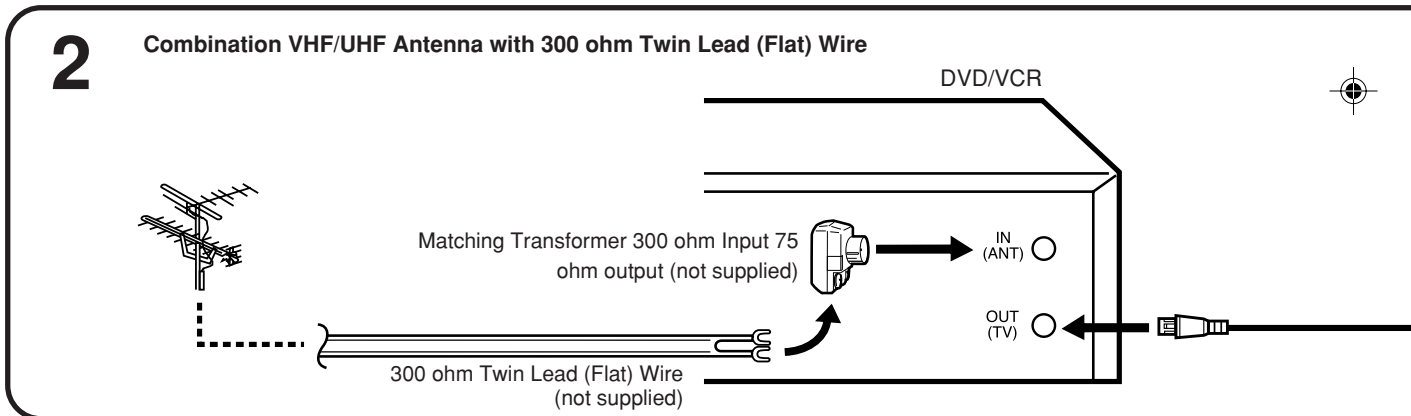
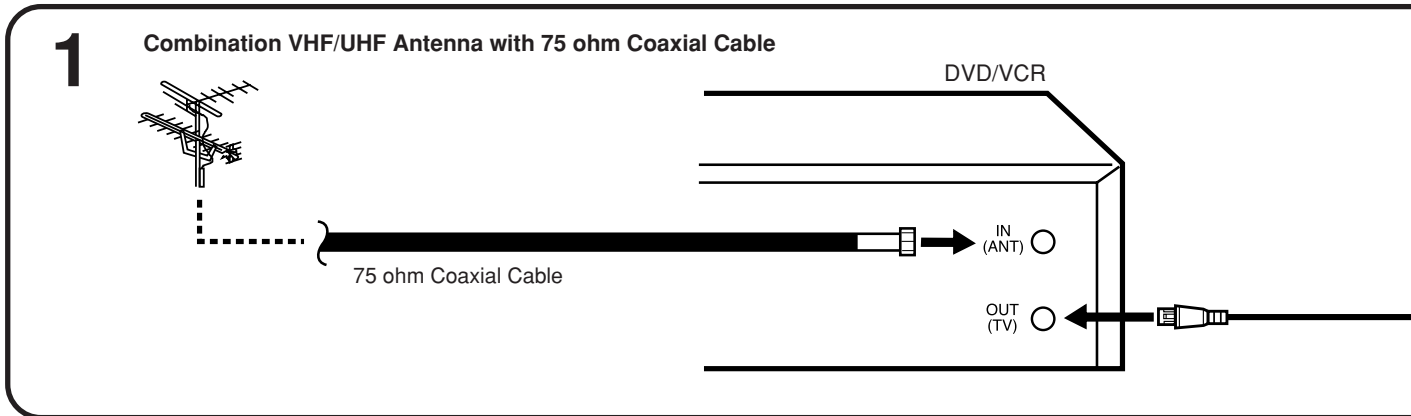

Note: If both VHF and UHF antennas have 300 ohm twin lead (flat) wires, use a combiner having two 300 ohm inputs and one 75 ohm output.

- Notes:**
- A clear picture will not be obtained by the DVD/VCR unless the antenna signal is good. Connect the antenna to the DVD/VCR properly.
 - For better quality recording, an indoor antenna or a telescopic antenna is not recommended. The use of an outdoor type antenna is required.
 - If you are not sure about the connection, please refer to qualified service personnel.



DVD/VCR to TV connection

After you have connected the antenna to the DVD/VCR, you must connect the DVD/VCR to the TV. Below are 3 common methods of connecting your DVD/VCR to a TV. Find the type of TV you are using and follow the connection diagram.

This DVD/VCR has a single 75 ohm output for connection to a TV. If your TV has separate VHF and UHF antenna inputs (numbers 2 and 3 below), use a splitter to connect the DVD/VCR to the TV for VHF and UHF reception.

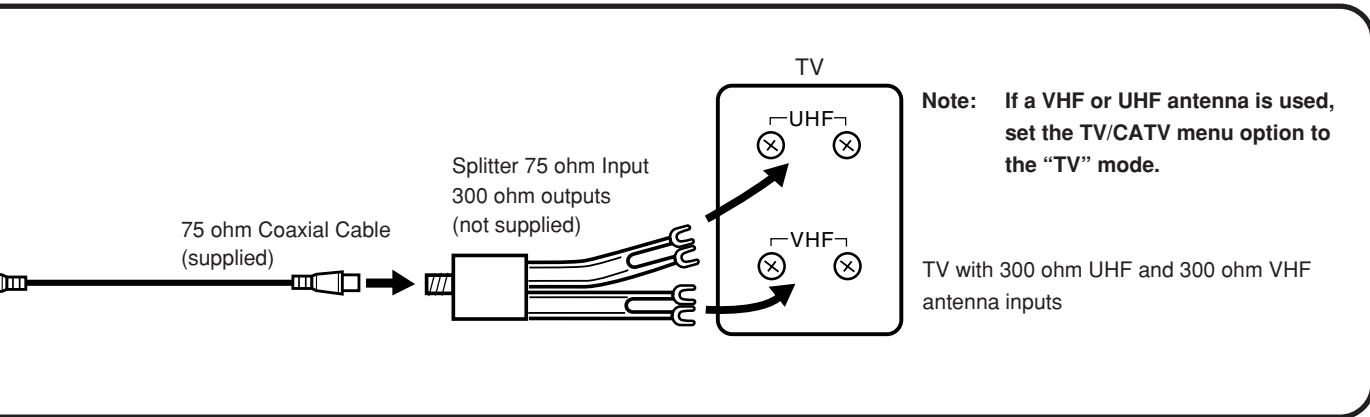
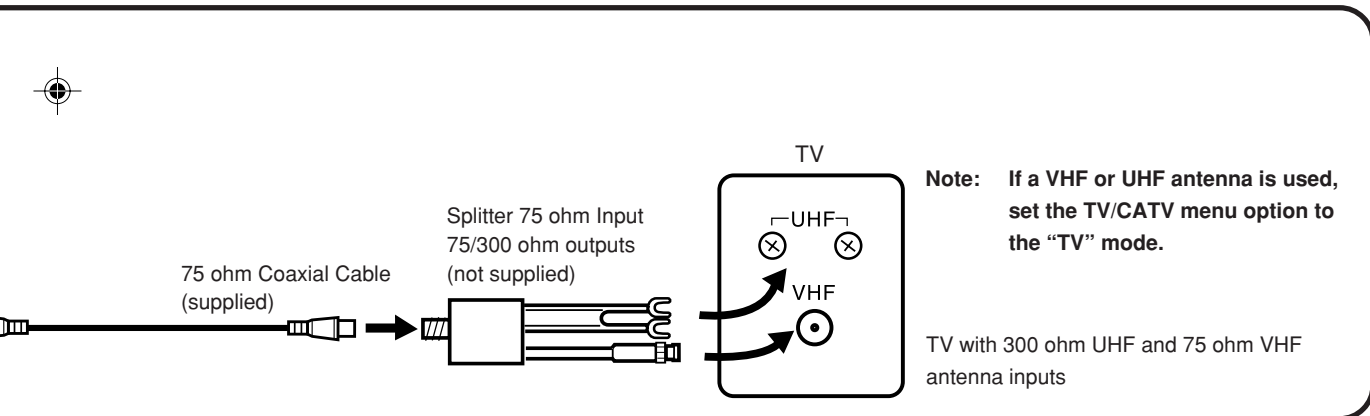
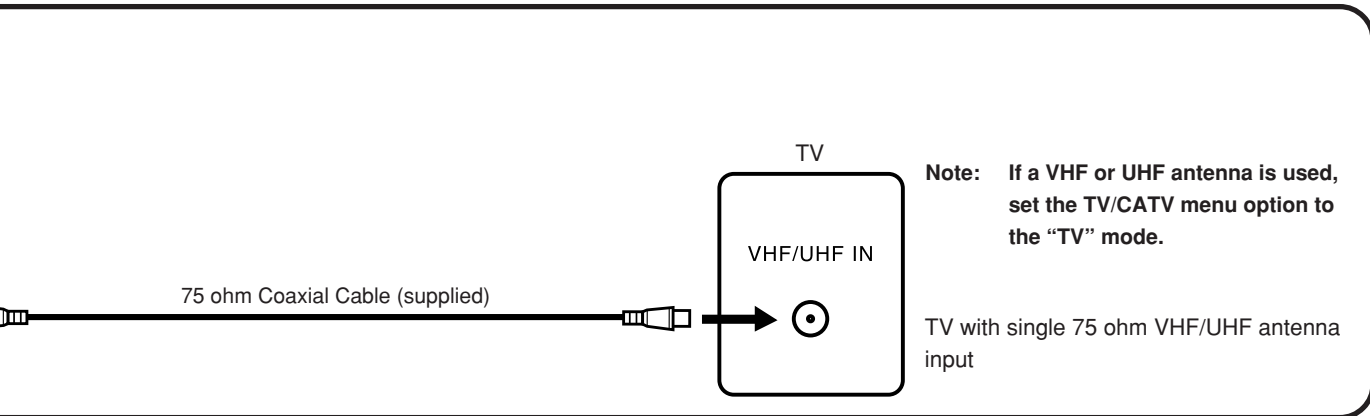

CATV (CABLE TV) connections

Many cable companies offer services permitting reception of extra channels including pay or subscription channels. This DVD/VCR has an extended tuning range and can be tuned to most cable channels without using a cable company supplied converter box, except for those premium channels which are intentionally scrambled. If you subscribe to a premium channel which is scrambled, you must have a descrambler box for proper reception.

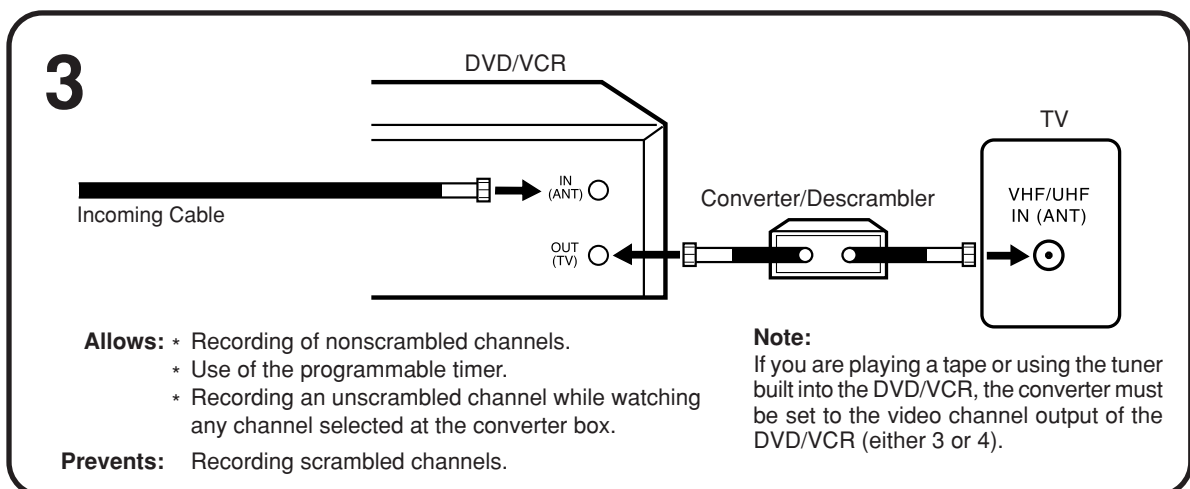
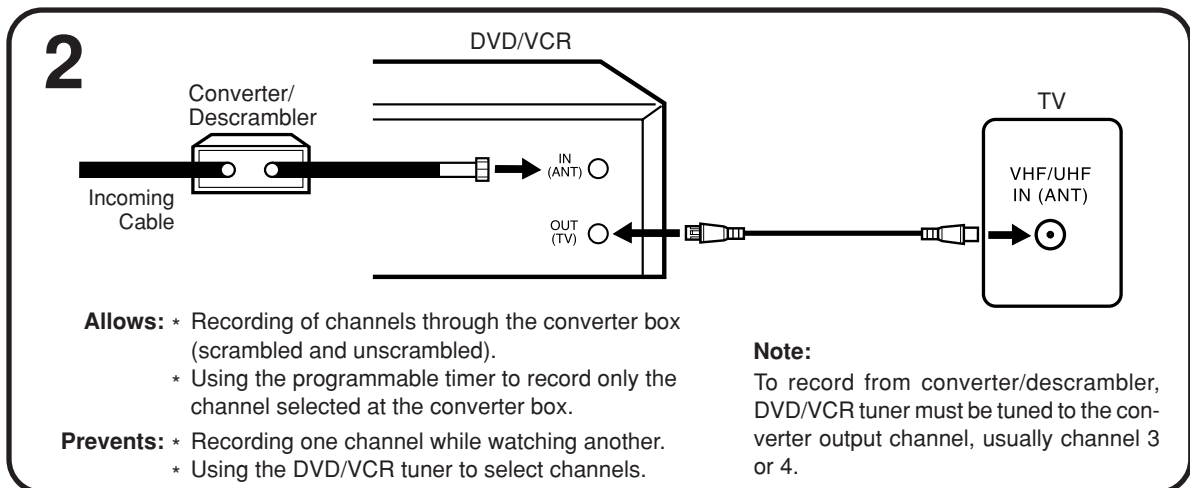
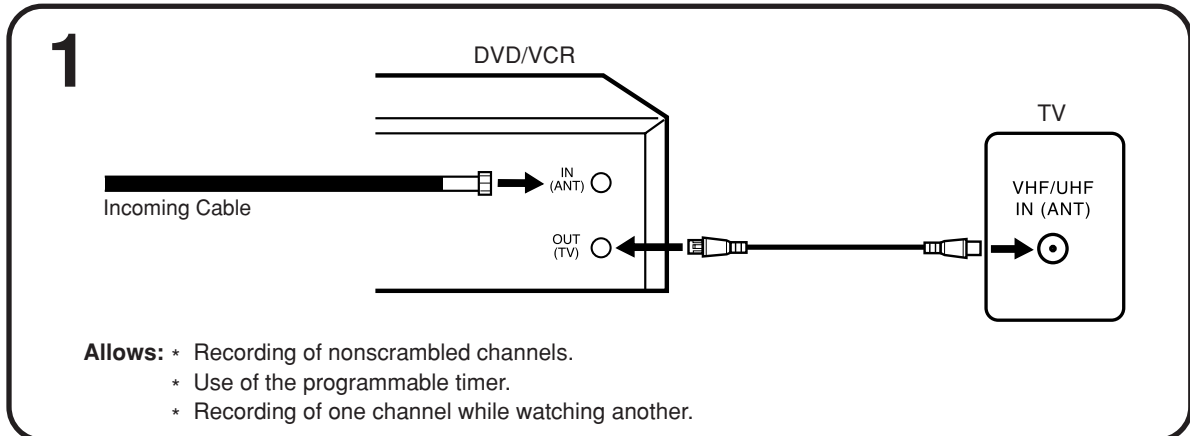

Note: Whenever a Converter/Descrambler box is placed before the DVD/VCR, you must tune the DVD/VCR to the output of the Converter/Descrambler box, usually channel 3 or 4.



IMPORTANT: Make sure the TV/CATV menu option is set to the "CATV" mode.

This DVD/VCR cannot receive scrambled programs since it does not contain a descrambler. In order to receive scrambled programs, your existing descrambler must be used. Descrambler boxes are available from cable companies. Consult your local cable company for more information concerning connection to their descrambler equipment. There are many ways to connect your DVD/VCR to a cable system. Below are six common methods of connection.

4

Allows:

- * Recording of one channel while watching another.
- * Using the programmable timer to record only the channel selected at the converter box.
- * Recording of all channels through the converter box.

Prevents:

- * Watching scrambled channels while recording another channel.
- * Using the DVD/VCR tuner to select channels.

5

Allows:

- * Recording of nonscrambled channels.
- * Recording of one channel while watching another.
- * Watching premium channels through the converter while recording nonscrambled channels.
- * Using the programmable timer.

Prevents: Recording scrambled channels.

6

Allows:

- * Recording of all channels through the converter box.
- * Recording a scrambled or unscrambled channel while watching another (scrambled or unscrambled) channel.
- * Using the programmable timer to record only the channel selected at the converter box.

Prevents: Using the DVD/VCR tuner to select channels.





Connecting to a TV

Connect the DVD/VCR to your TV.

Note: This method transports VHS and DVD-video signals. For enhanced DVD-video performance, we recommend you also connect the S-video or ColorStream® component video outputs to your TV/monitor [19](#).

Connecting to a TV

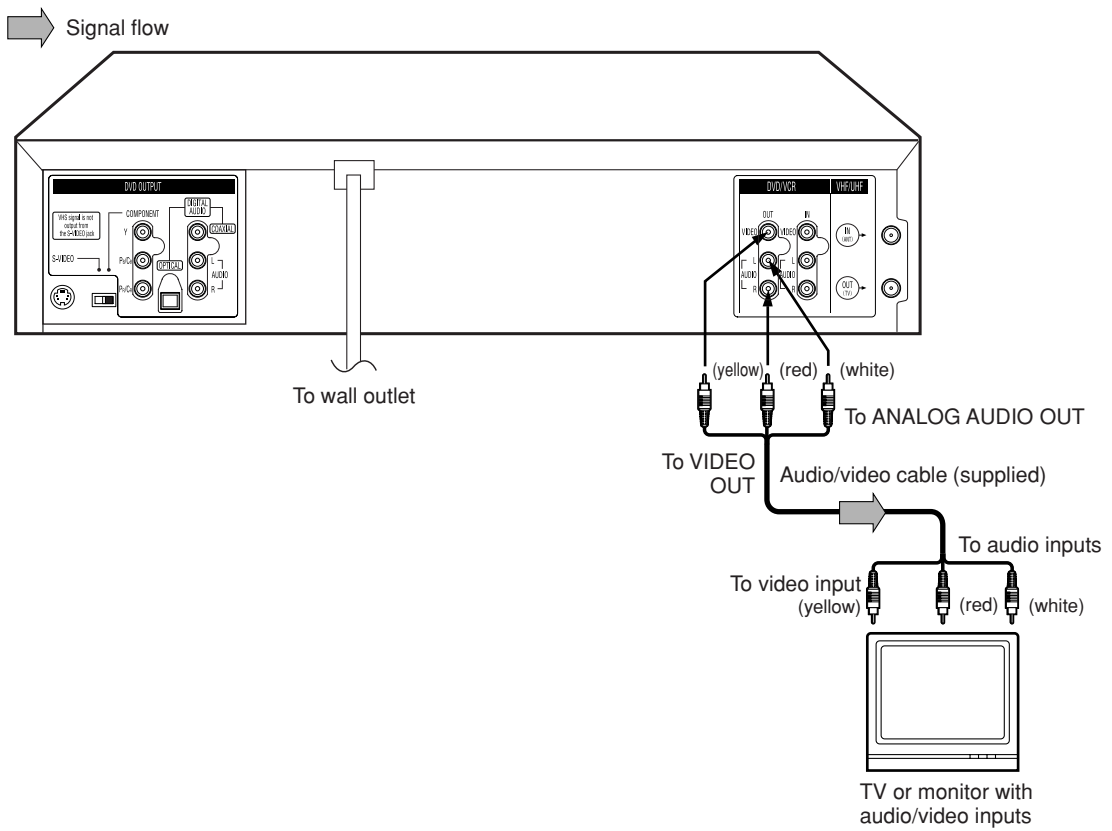

Notes:

- Refer to the owner's manual of the connected TV as well.
- When you connect the DVD/VCR to your TV, be sure to turn off the power and unplug both units from the wall outlet before making any connections.
- If your television set has one audio input, connect the left and right audio outputs of the DVD/VCR to a Y cable adapter (not supplied) and then connect to your TV.
- Connect the DVD/VCR directly to your TV. If you connect the DVD/VCR to a VCR, TV/VCR combination or video selector, the playback picture may be distorted as DVD video discs are copy protected.





S-video output/input

An S-Video connection is superior to Video (Yellow) output. Use this method for DVD playback when the connected television has S-Video input, and does not have component video inputs.

Component video outputs/inputs

PROGRESSIVE outputs/inputs

Some TVs or monitors are equipped with component video inputs that are capable of reproducing a progressively scanned video signal. Connecting to these inputs allows you to view the highest quality pictures with less flicker.

INTERLACED outputs/inputs

Some TVs or monitors are equipped with component video inputs. Connecting to these inputs allows you to enjoy the highest quality DVD picture playback.

Notes:

- Actual labels for component video inputs may vary depending on the TV manufacturer. (ex. Y, R-Y, B-Y or Y, CB, CR)
- In some TVs or monitors, the color levels of the playback picture may be reduced slightly or the tint may change. In such a case, adjust the TV or monitor for optimum performance.

Connecting to an audio system and TV equipped with S-video input/component video inputs

Note: The S-video output and component video output transports the DVD-video signal exclusively and will deliver enhanced DVD video picture performance.

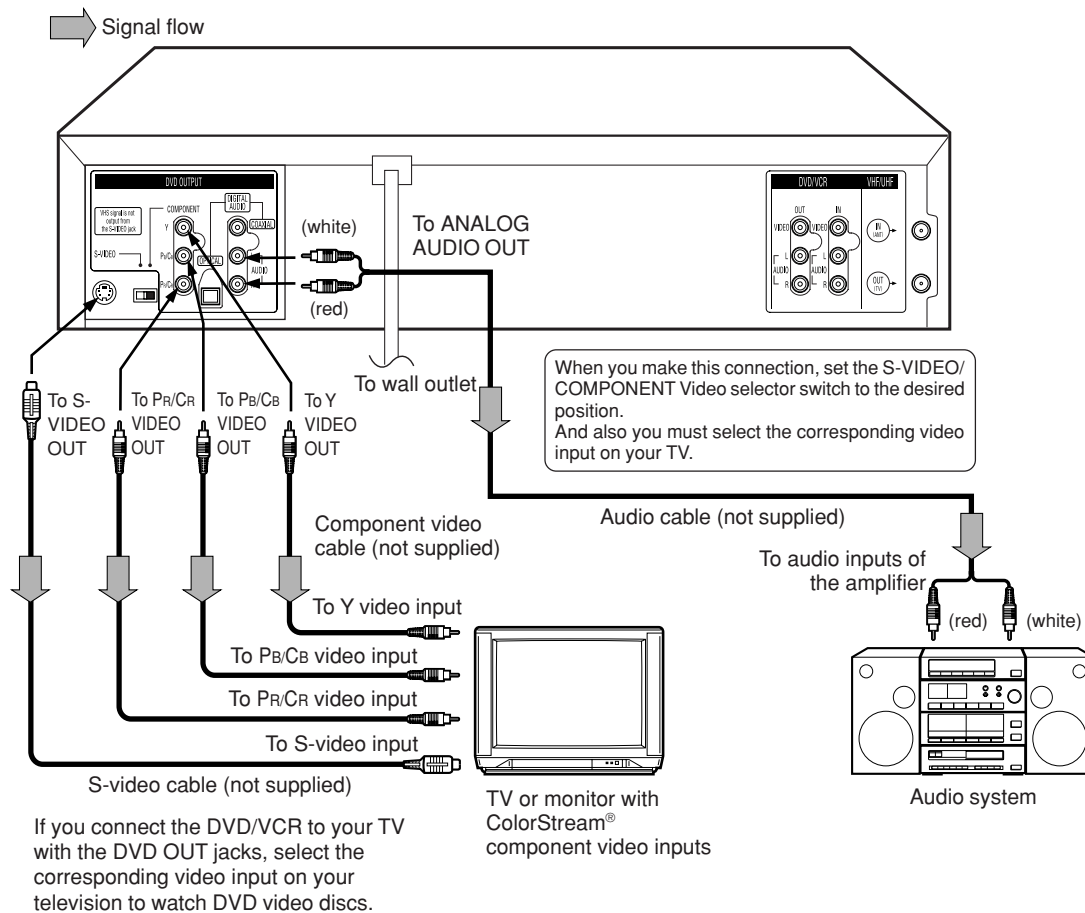

Notes:

- Refer to the owner's manual of the connected equipment as well.
- When you connect the DVD/VCR to other equipment, be sure to turn off the power and unplug all of the equipment from the wall outlet before making any connections.
- If you place the DVD/VCR near a tuner or radio, the radio broadcast sound might be distorted. In this case, place the DVD/VCR away from the tuner and radio.
- The output sound of the DVD/VCR has a wide dynamic range. Be sure to adjust the receiver's volume to a moderate listening level. Otherwise, the speakers may be damaged by a sudden high volume sound.
- Turn off the amplifier before you connect or disconnect the DVD/VCR's power cord. If you leave the amplifier power on, the speakers may be damaged.
- **When connecting to a TV using the Video or S-video jack, make sure that the Progressive indicator "P" on the display window is not lit. If it is lit, the Video and S-video outputs do not feed the correct signals and you cannot see any picture. To turn off the Progressive indicator, select PROGRESSIVE scan Off [66].**



Connecting to optional equipment

You can enjoy high quality dynamic sounds of DVD video discs or audio CDs by connecting the DVD/VCR to optional audio equipment.

For connection to your TV, see "Connecting to a TV" 18 19.

• This selection uses the following reference mark.

- : Front speaker
- : Rear speaker
- : Sub woofer
- : Center speaker
- ⇒ : Signal flow

Connecting to an amplifier equipped with a Dolby Digital decoder

Dolby Digital

Dolby Digital is the surround sound technology used in theaters showing the latest movies, and is now available to reproduce this realistic effect in the home. You can enjoy motion picture and live concert DVD video discs with this dynamic realistic sound by connecting the DVD/VCR to a 6 channel amplifier equipped with a Dolby Digital decoder or Dolby Digital processor. If you have a Dolby Pro Logic Surround decoder, you will obtain the full benefit of Pro Logic from the same DVD movies that provide full 5.1-channel Dolby Digital soundtracks, as well as from titles with the Dolby Surround mark.

Manufactured under license from Dolby Laboratories. "Dolby" "Pro Logic" and the double-D symbol are trademarks of Dolby Laboratories.

- Use DVD video discs encoded via the Dolby Digital recording system.

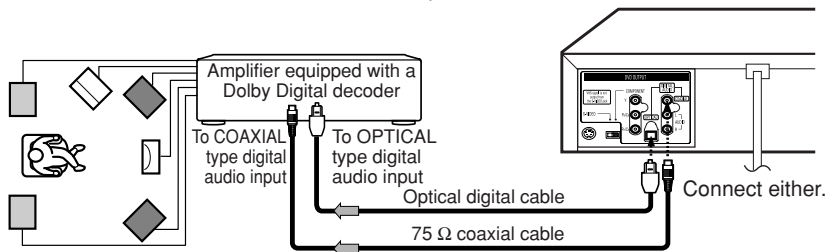

Connecting to an amplifier equipped with Dolby Surround Pro Logic

Dolby Surround Pro Logic

You can enjoy the dynamic realistic sound of Dolby Surround Pro Logic by connecting an amplifier and speaker system (right and left front speakers, a center speaker, and one or two rear speakers).

- With an amplifier equipped with Dolby Digital
Connect the equipment the same way as described in "Connecting to an amplifier equipped with a Dolby Digital decoder." Refer to that amplifier's owner's manual and set the amplifier so you can enjoy Dolby Surround Pro Logic sound.
- With an amplifier not equipped with Dolby Digital
Connect the equipment as follows.

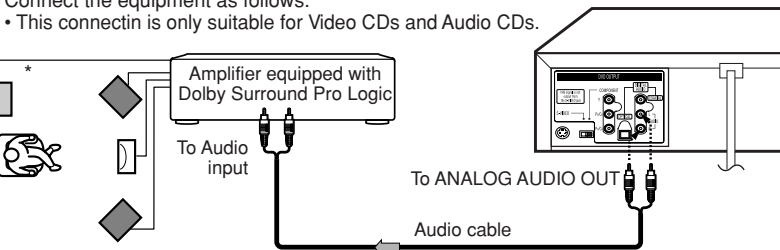

* Connect one or two rear speakers. The output sound from the rear speakers will be monaural even if you connect two rear speakers.

Connecting to an amplifier equipped with a DTS decoder

Digital Theater Systems (DTS)

DTS is a high quality surround technology used in theaters and now available for home use, on DVD video discs or audio CDs.

If you have a DTS decoder or processor, you can obtain the full benefit of 5.1 channel DTS encoded sound tracks on DVD video discs or audio CDs.

"DTS" and "DTS Digital Out" are trademarks of Digital Theater Systems, Inc.

- Use DVD video discs or audio CDs encoded via the DTS recording system.

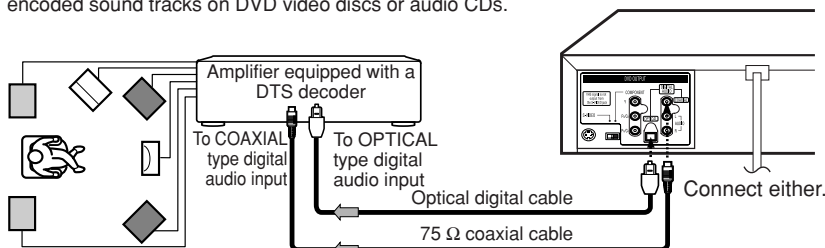



Warning

When playing DTS-encoded discs (audio CDs), excessive noise may be output from the analog stereo jacks. To avoid possible damage to the audio system, you should take proper precautions when the ANALOG AUDIO OUT (L/R) jacks of the DVD/VCR are connected to an amplification system. (Do not leave the ANALOG AUDIO OUT (L/R) wires dangling.) To enjoy DTS Digital Surround™ playback, an external 5.1 channel DTS Digital Surround™ decoder system must be connected to the BITSTREAM/PCM AUDIO OUT jack of the DVD/VCR.

Connecting to an amplifier equipped with an MPEG2 audio decoder

MPEG2 sound

You can enjoy motion picture and live concert DVD video discs with dynamic realistic sound by connecting an amplifier equipped with an MPEG2 audio decoder or MPEG2 audio processor.

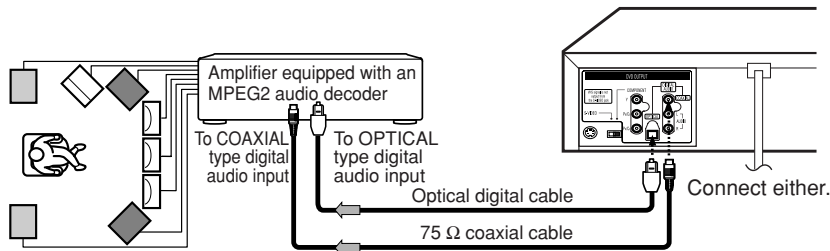

- Use DVD video discs encoded via the MPEG2 recording system.

Connecting to an amplifier equipped with a digital audio input

2 channel digital stereo

You can enjoy the dynamic sound of 2 channel digital stereo by connecting an amplifier equipped with a digital audio input and speaker system (right and left front speakers).

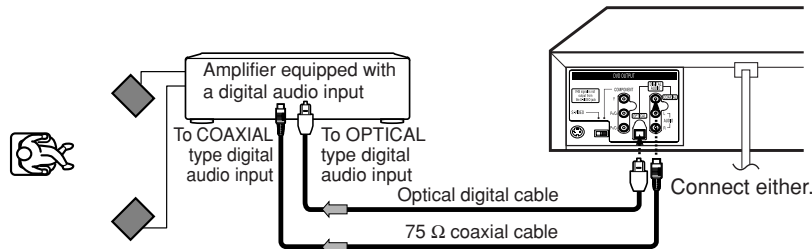

Notes:

- DO NOT connect the BITSTREAM/PCM AUDIO OUT jack of the DVD/VCR to the AC-3 RF input of a Dolby Digital Receiver. This input on your A/V Receiver is reserved for Laserdisc use only and is incompatible with the BITSTREAM/PCM AUDIO OUT jack of the DVD/VCR.
- Connect the BITSTREAM/PCM AUDIO OUT jack of the DVD/VCR to the "OPTICAL" or "COAXIAL" input of a Receiver or Processor.
- Refer to the owner's manual of the connected equipment as well.
- When you connect the DVD/VCR to other equipment, be sure to turn off the power and unplug all of the equipment from the wall outlet before making any connections.
- The output sound of the DVD/VCR has a wide dynamic range. Be sure to adjust the receiver's volume to a moderate listening level. Otherwise, the speakers may be damaged by a sudden high volume sound.
- Turn off the amplifier before you connect or disconnect the DVD/VCR's power cord. If you leave the amplifier power on, the speakers may be damaged.



Setting the video channel

When a TV is connected with the 75 ohm coaxial cable only. To view playback of a recorded tape or DVD disc, or to watch a program selected by the VCR's channel selector, the TV must be set to channel 3 or 4 (video channel).

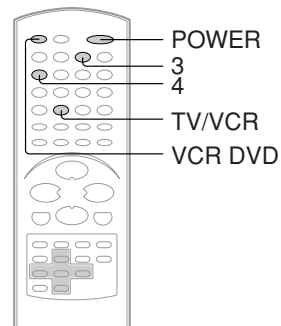

Setting the video channel

1 Press and hold 3 or 4 on the remote for 3 seconds in standby mode.



The video channel will start to flash for 3 seconds in the display window.

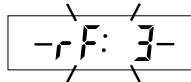

2 Press POWER to turn on the DVD/VCR.



3 Press VCR DVD selector to select the VCR mode.



The VCR indicator on the front panel will light.



4 Turn ON the TV and set to CH 3 or 4 to correspond with the channel selected in step 1.

5 Press TV/VCR to select the VCR position.



The VCR indicator will appear in the display window.

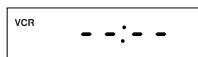

6 Select any channel to receive a TV station in your area. The channel number will appear on the screen for about 4 seconds.

For a push-button TV tuner

If CH 3 or 4 corresponding to the video channel cannot be tuned on your TV, proceed as follows: set the VCR 3/4 channel selector and the TV to CH 3 or 4, play back a prerecorded tape and tune the TV to receive a sharp color picture from the video cassette recorder. Refer to your TV owner's manual for details.

Note:

If the unit does not operate properly, or No key operation (by the unit and/or the remote control): Static electricity, etc., may affect the player's operation. Disconnect the AC power cord once, then connect it again.



Setting the language

You can choose from three different languages (English, French and Spanish) for the on-screen displays.

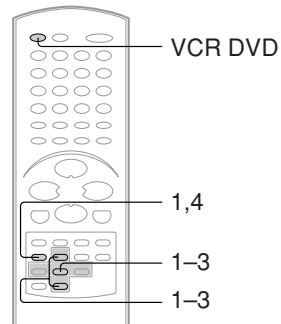

Setting the language

Preparation:

- Turn ON the TV and select to the corresponding video input.
- Press **VCR DVD** selector to select the VCR mode. (The VCR indicator will light.)

1 Press VCR MENU.



The VCR menu screen will appear. Press **SET +** or **-** to select "SYSTEM SETUP", then press **ENTER**. If you use the unit for the first time and press **VCR MENU**, instead of the main menu screen the "SYSTEM SETUP" menu screen in step 2 may appear.

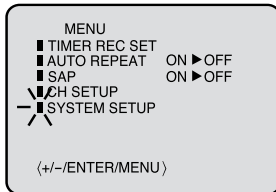
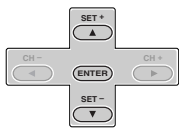

4 Press VCR MENU until the MENU screen is cleared.



Notes:

- Both the VCR and the DVD have their own player menus **57**.
- If no buttons are pressed for more than 60 seconds, the VCR MENU screen will return to normal TV-operation automatically.

Basic setup

2 Press SET + or - to select "LANGUAGE", then press ENTER.

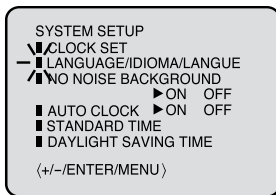
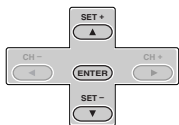

3 Press SET + or - to select the desired language: English (ENGLISH), Spanish (ESPAÑOL) or French (FRANCAIS), then press ENTER.

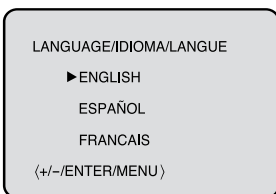
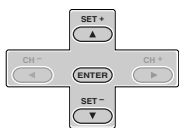

Clock setting

The AUTO CLOCK function will automatically set the built-in clock (Month, Day, Year and Time) when the DVD/VCR is connected to an Antenna or Cable system and it is turned off. The DVD/VCR searches for a station in your area containing the necessary AUTO CLOCK setting signals. Once received, it will take approximately 4 minutes for the clock to set itself automatically.

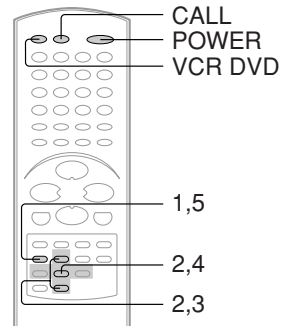

AUTO CLOCK setting

Preparation:

- Turn ON the TV and select the corresponding video input.
- Press **VCR DVD** selector to select the VCR mode. (The VCR indicator will light.)

1 Connect the Antenna or Cable system.
• If you use a cable box, turn it on.

2 Plug the AC Power cord to the AC outlet.

3 Make sure the DVD/VCR is turned off.
• If you press **POWER**, the Auto Clock set is not programmed.

4 Wait at least three minutes and press **POWER**.

5 Press **CALL** to check the clock setting on the on screen display.

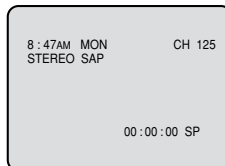

6 If the clock is not set, check the antenna condition. The AUTO CLOCK may not function properly if the reception condition is not good.

AUTO CLOCK adjustment

The auto clock adjustment will be updated at 6:00 AM, 12:00 PM and 6:00 PM everyday when the DVD/VCR turned off.

- If you use a cable box and you want AUTO CLOCK adjustment to be performed, the cable box must be left on.
- The AUTO CLOCK adjustment is not effective when there is a difference of more than 5 minutes exists between the built-in clock time and the actual time.

To set AUTO CLOCK to off

When shipped from factory the AUTO CLOCK is set to "ON". But if you do not want AUTO CLOCK setting:

1 Press **VCR MENU**.

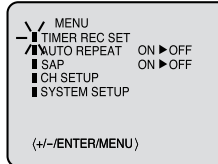

2 Press **SET +** or **-** to select "SYSTEM SETUP", then press **ENTER**.

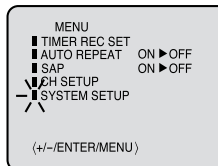
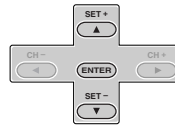

3 Press **SET +** or **-** to select "AUTO CLOCK".

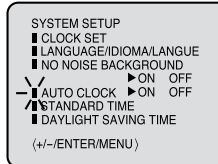
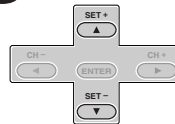

4 Press **ENTER** to select "OFF".

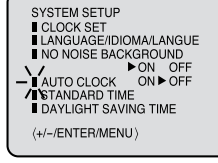
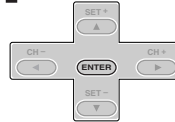

5 Press **VCR MENU** repeatedly to return to the normal screen.



- When the AUTO CLOCK is set to "OFF", the AUTO CLOCK adjustment does not function.
- Set the clock manually **[26]**.



To set STANDARD TIME

In the rare event that you live within broadcast range of two stations in two different time zones, the DVD/VCR may recognize the wrong station for the AUTO CLOCK setting. To correct the situation:

1 Press VCR MENU.

VCR MENU
SETUP

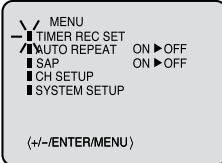

(+/-)/ENTER/MENU

2 Press SET + or - to select "SYSTEM SETUP", then press ENTER.

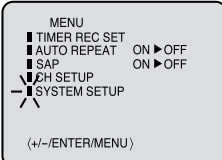
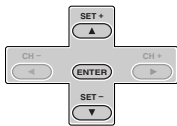

(+/-)/ENTER/MENU

3 Press SET + or - to select "STANDARD TIME", then press ENTER.

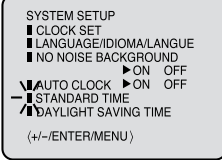
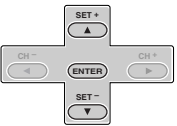

(+/-)/ENTER/MENU

4 Press SET + or - to select your time zone, then press ENTER.

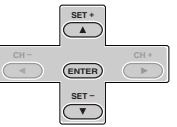

ATLANTIC	: GMT-4hours
EASTERN	: GMT-5hours
CENTRAL	: GMT-6hours
MOUNTAIN	: GMT-7hours
PACIFIC	: GMT-8hours
ALASKA	: GMT-9hours
HAWAII	: GMT-10hours
AUTO	: AUTO SET

(GMT: Greenwich Mean Time)

5 Press VCR MENU twice to return to the normal screen.

VCR MENU
SETUP



Notes:

- To be able to select the standard time, the clock must first be set by AUTO CLOCK once.
- If you live in Newfoundland and the AUTO CLOCK does not function properly, set the AUTO CLOCK menu option to "OFF" and set the clock manually.

To set DAYLIGHT SAVING TIME

You can set the DAYLIGHT SAVING TIME automatically or manually.

1 Press VCR MENU. Press SET + or - to select "SYSTEM SETUP", then press ENTER.

VCR MENU
SETUP

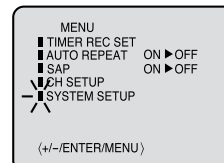
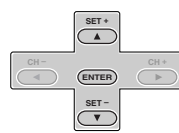

(+/-)/ENTER/MENU

2 Press SET + or - to select "DAYLIGHT SAVING TIME", then press ENTER.

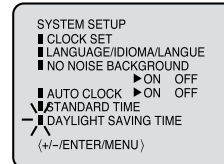
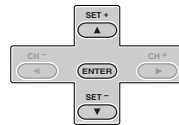

(+/-)/ENTER/MENU

3 Press SET + or - to select one of the options, then press ENTER. Press VCR MENU until the MENU screen is cleared.

VCR MENU
SETUP

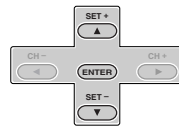

- ON:** for manual setting (forward one hour)
- OFF:** for manual setting (back one hour)
- AUTO:** for automatic setting (read XDS in the signal)

When you want to set the DAYLIGHT SAVING TIME manually, on the first Sunday in April you set to "ON", and on the last Sunday in October you set to "OFF".



(+/-)/ENTER/MENU

Notes:

- When shipped from factory, the DAYLIGHT SAVING TIME is set to "AUTO" position.
- When the clock is not set, DAYLIGHT SAVING TIME setting is not available.
- When there is no DAYLIGHT SAVING TIME in your area, always select "OFF" position in step 3.

Clock setting (continued)

If the AUTO CLOCK process did not set the date and time correctly, you must set them manually for timer recording and DAYLIGHT SAVING TIME.

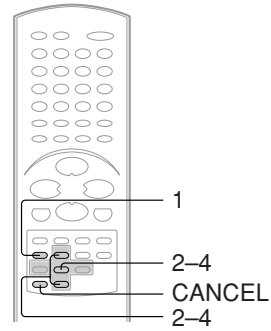

Manual clock setting

EXAMPLE: Setting the clock to "8:30 AM" March, 27 (SAT), 2004.

1 Press VCR MENU.



2 Press SET + or - to select "SYSTEM SETUP", then press ENTER.

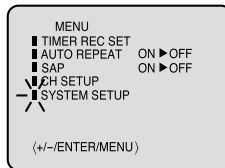
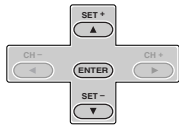

6 After setting the clock, date and time starts functioning automatically.



To make corrections any time during the process

Press **CANCEL** repeatedly until the item you want to change blinks, then press **SET + or -**.

Note:

After a power failure or disconnection of the power, the timer settings will be lost. In this case, reset the present time.

3 Press SET + or - to select "CLOCK SET", then press ENTER.

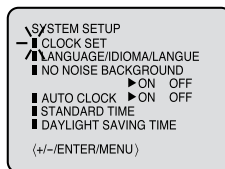
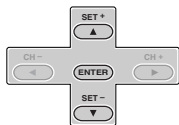

4 Press SET + or - to set the month, then press ENTER.

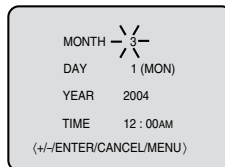
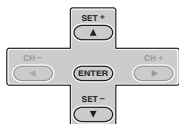

5 Set the day, year and time as in step 4.

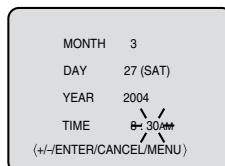



Tuner setting

This DVD/VCR is equipped with a channel memory feature which allows channels to skip up or down to the next channel set into memory, skipping over unwanted channels. Before selecting channels, they must be programmed into the DVD/VCR's memory. In addition to normal VHF and UHF channels, this DVD/VCR can receive up to 113 Cable TV channels. To use this DVD/VCR with an antenna, set the TV/CATV menu option to the TV mode. When shipped from the factory, this menu option is in the CATV mode.

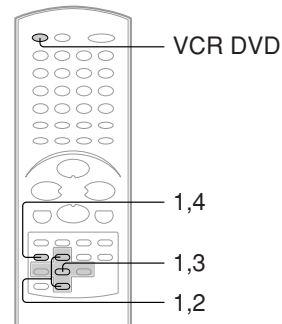

TV/CATV selection

Preparation:

- Turn ON the TV and select to the corresponding video input.
- Press **VCR DVD** selector to select the VCR mode. (The VCR indicator will light.)

1 Press VCR MENU. Press SET + or - to select "CH SETUP", then press ENTER.

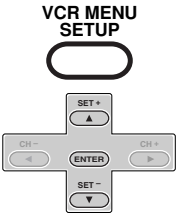
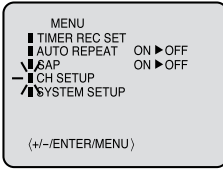
2 Press SET + or - to select "TV/CATV".



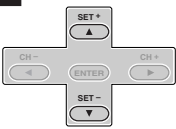
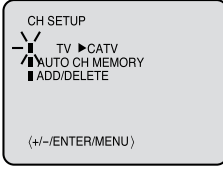

3 Press ENTER to select the TV or CATV mode. The arrow indicates the selected mode.

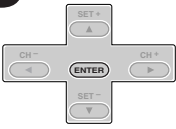
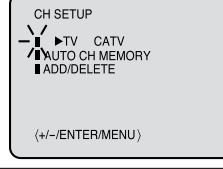
TV - VHF/UHF channels
CATV - CABLE TV channels

4 Press VCR MENU until the menu screen is cleared.



Setting channels automatically

1 Repeat left step 1 and press SET + or - to select "AUTO CH MEMORY".

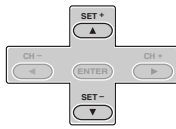
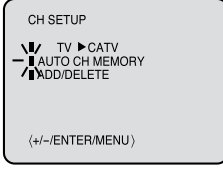
2 Press ENTER.

Auto tuning will begin. The channel display will count up and when finished, the screen returns to normal.



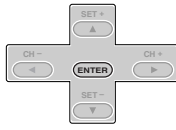
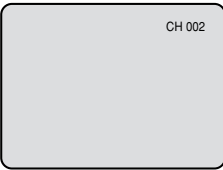

Basic setup

Note:
You can't select "CH SETUP" if you set the channel to "L1" or "L2".

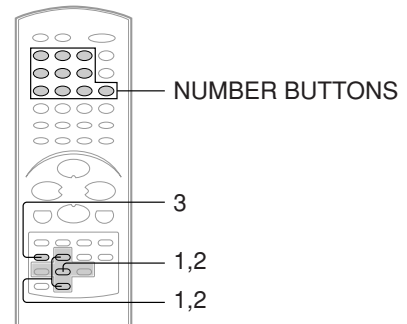

Tuner setting (continued)



To ADD/DELETE channels

1 Repeat the step 1 on page 27. Then press **SET +** or **-** to select the “ADD/DELETE” and press **ENTER**.

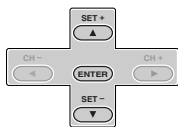

2 To Add or Delete desired channels

1 Press **Number buttons** or **SET +** or **-** to select a channel number you want to add or delete.

2 To add channels
Press **ENTER** until “ADD” appears on the screen.

To delete channels
Press **ENTER** until “DELETE” appears on the screen. The channel number will blink.

3 Repeat **1** to **2** to add or delete other channel.

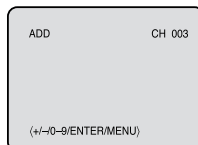
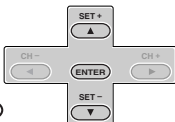
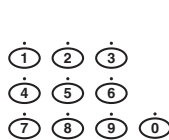

3 Press **VCR MENU** until the menu screen is cleared.



Noise elimination

When you don't want to receive a weak signal broadcast, a Blue back screen can be obtained by selecting the NO NOISE BACKGROUND “ON”. When the unit is shipped from the factory, the NO NOISE BACKGROUND is set to “ON”.

1 Repeat the steps 1~2 on page 26 and press **SET +** or **-** to select “NO NOISE BACKGROUND”.

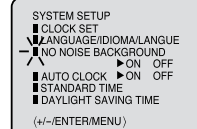
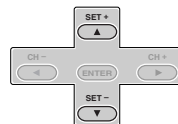

2 Press **ENTER** to select “ON” or “OFF” position.

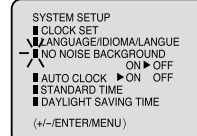
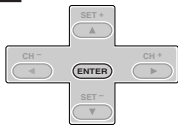

3 Press **VCR MENU** until the menu screen is cleared.





Loading and unloading a cassette tape

Use only video cassette tapes marked **VHS** and **SVHS**.

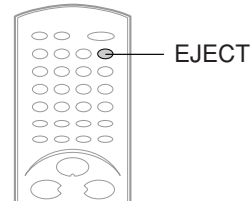

Loading

Push the center of the tape until it is automatically inserted.

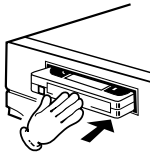

Insert the cassette tape with its labeled side facing up and the erase prevention tab positioned at your left. An inverted cassette tape cannot be inserted.

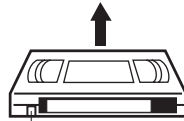

Erase prevention tab

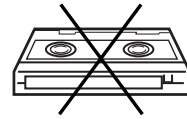

Automatic power ON

When you insert a cassette tape the DVD/VCR power will turn ON automatically.

Automatic playback

When loading a cassette tape without an erase prevention tab, playback will start automatically.

Unloading

1 Press **EJECT** on the front panel or on the Remote.

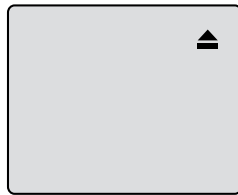

2 Remove the cassette tape.

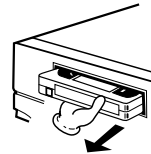

Automatic tape eject

This DVD/VCR will automatically rewind the tape when the tape has ended. Once the tape is rewound to its beginning, the cassette tape will be ejected automatically.

To prevent accidental erasure

To prevent accidental erasure

Remove the erase prevention tab with a screwdriver.

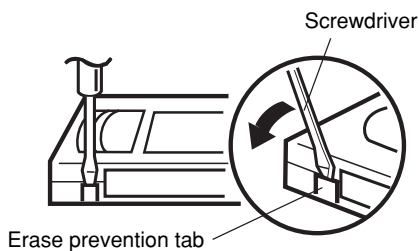

To record again

Cover the hole with a piece of adhesive tape.

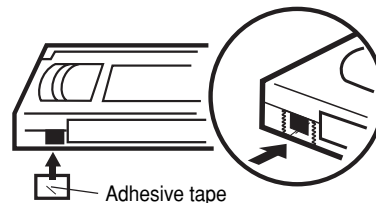

Tape speed and maximum recording time

Tape Speed	Video cassette tape				
	T-160	T-120	T-90	T-60	T-30
SP (Standard Play)	2-2/3 hours	2 hours	1-1/2 hours	1 hour	30 minutes
SLP (Super Long Play)	8 hours	6 hours	4-1/2 hours	3 hours	1-1/2 hours

Cassette tape playback

To play a prerecorded tape.

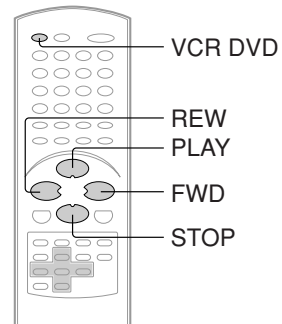

Playback

Preparation:

- Turn ON the TV and select the corresponding video input.
- Press **VCR DVD** selector to select the VCR mode. (The VCR indicator will light).

1 Load a prerecorded tape

(When loading a cassette tape without the erase prevention tab, playback will start automatically).

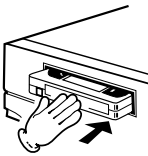

2 To start playback

Press **PLAY**. Playback will start. "▶" will appear on the screen for about 4 seconds.



To stop playback

Press **STOP** once. The tape will stop but remain fully loaded and ready to play. "■" will appear on the screen for about 4 seconds.

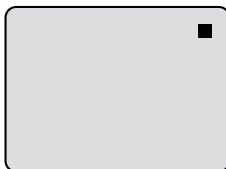

Notes:

- This VCR selects the playback tape speed SP, LP or SLP automatically.
- The Cassette tape and DVD disc can be played back simultaneously. If you press **VCR DVD** selector, the tape playback and DVD playback alternate with each other on the screen (via CH3, 4 or video connection).

Rewind or forward the tape

Stop the playback or recording via **STOP** on remote.

To rewind the tape:

Press **REW**.

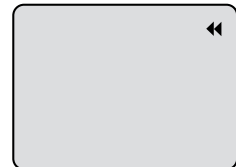

To forward the tape:

Press **FWD**.



To discontinue the tape-winding, press **STOP**. To switch to playback directly (without **STOP**), press **PLAY**.

■ Forward/Reverse picture search mode

When the tape is being winded, you can switch to picture search mode (see next page). To do this, press **REW** or **FWD** and hold it down. The unit will resume the tape advance or rewinding as soon as the button is released.



Special playback

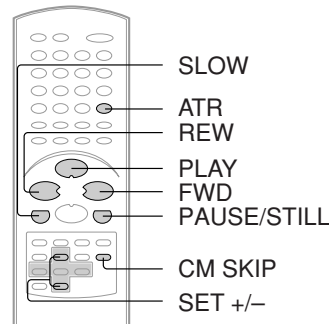

Picture search

Reverse picture search function

Press **REW** once or twice during playback.

Forward picture search function

Press **FWD** once or twice during playback.

To return to playback, press **PLAY**.

SPEED SEARCH TIMES

TAPE SPEED	PICTURE SEARCH SPEED	
	PRESS ONCE	PRESS TWICE
SP (Standard Play)	3 X	5 X
LP (Long Play)	7 X	9 X
SLP (Super Long Play)	9 X	15 X

Still picture

Press **PAUSE/STILL** during playback.

To resume normal playback, press **PLAY** or **PAUSE/STILL**.

Slow motion

During playback press **SLOW**.

To return to playback, press **PLAY** or **SLOW**.

Slow tracking and vertical lock adjustment

If noise bars appear in the picture during slow motion, press the **SET +/-** to reduce the noise bars.

If the still picture jitters excessively, press **SET +/-** to stabilize the still picture.

Frame by frame picture

Press **PAUSE/STILL** during playback.

Press **SLOW** repeatedly: The picture advances frame by frame.

To return to playback, press **PLAY** or **PAUSE/STILL**.

CM skip

Press **CM SKIP** during playback. The DVD/VCR will search forward through approximately 30 seconds of the tape (e.g. unwanted commercial time) for each press of **CM SKIP** (maximum six presses) and then resume normal playback.

For example : 1 press: 30 seconds of tape
2 press: 60 seconds of tape
3 press: 90 seconds of tape

Adjusting tracking condition

Automatic tracking adjustment

Whenever you insert a tape and start playback, the automatic tracking feature continuously analyzes the signal to enable optimum picture quality during playback.

Manual tracking adjustment

If automatic tracking cannot eliminate noises well during playback, press **SET +/-** to eliminate the noise. "MANUAL TR." will appear on the screen. Press it briefly for a fine adjustment, or press and hold for a coarse adjustment.

Press **ATR** to reactivate automatic tracking again.

"AUTO TR." will appear on the screen.

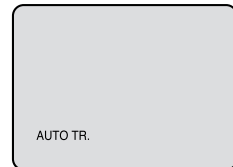

Notes:

- The audio output is muted during SPEED SEARCH, STILL, FRAME ADVANCE and SLOW MOTION.
- During picture search mode there will be noise bars. This is not a defect.
- Playback will commence after approx. 5 minutes to protect the video tape against excessive wear during pause mode.

Video head cleaning

Video head clogging

The video heads are the means by which the DVD/VCR reads the picture from the tape during playback. In the unlikely event that the heads become dirty enough to be clogged, no picture will be displayed. This can easily be determined if, during playback of a known good tape, there is good sound, but no picture (picture is extremely snowy). If this is the case, have the DVD/VCR checked and cleaned by qualified service personnel.



Good Picture



Snowy Picture

Notes:

- DO NOT ATTEMPT TO CLEAN THE VIDEO HEADS OR SERVICE THE UNIT BY REMOVING THE REAR COVER.
- Video heads may eventually wear out and should be replaced when they fail to produce clear pictures.
- To help prevent video head clogging, use only good quality VHS tapes. Discard worn out tapes.

Playback (VCR)

Convenience function

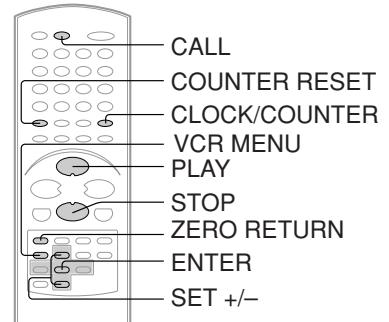

Repeat playback

The entire video tape will play until its end. The tape will automatically rewind to the beginning and the playback will be repeated.

1 Press VCR MENU.

Press **SET +** or **-** to select "AUTO REPEAT".

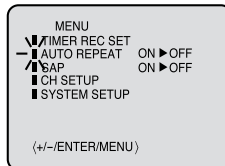
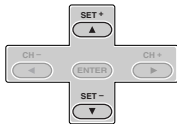

2 Press ENTER to select "ON" or "OFF".

If "ON" is selected, the playback will be repeated endlessly.

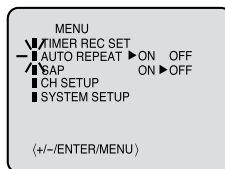
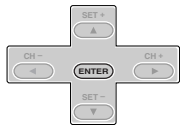

3 Press VCR MENU until the menu screen is cleared.



If you press **CALL**, "⏪" will appear on the screen **11**.

4 To commence playback, press PLAY.

The playback will be repeated endlessly.



Zero return function

This function rewinds the tape to the "00:00:00" counter position automatically.

1 Press CLOCK/COUNTER.

The counter display shows the tape running time during playback or recording.

CLOCK/COUNTER



2 Press COUNTER RESET at the desired tape position.

The counter display will be reset to "00:00:00" position (e.g. the beginning of recording).

COUNTER RESET ANGLE



3 Press STOP when playback or recording is completed. Press ZERO RETURN.

The tape will automatically rewind or fast forward to the "00:00:00" counter position.



ZERO RETURN JUMP



To cancel repeat mode:

Follow the above step 1, then press **ENTER** to select "OFF" position. Press **VCR MENU** to return to the TV.

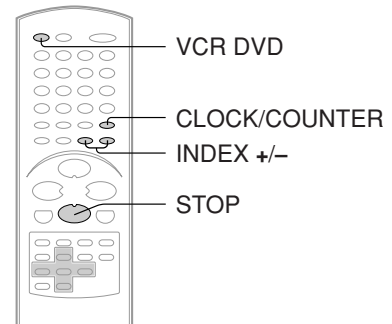

Clock/counter display

Press **CLOCK/COUNTER**. The clock and tape counter alternate with each other in the display window.

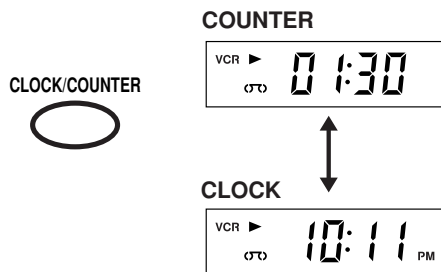

Press **VCR DVD** selector. The DVD mode and the VCR mode alternate with each other in the display.

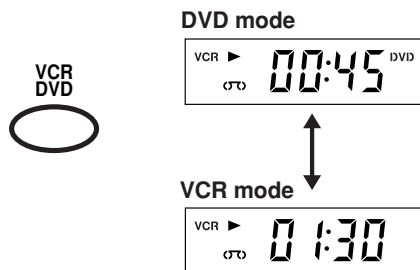

Notes:

- If you rewind the tape beyond "00:00:00", a minus sign ("-") will be displayed in front of the time.
- When you load a tape, the counter will reset to "00:00:00".
- The counter does not function on nonrecorded (blank) sections of the tape. When you rewind, fast forward or play tapes through blank sections, the counter stops.

Video index search system

This function enables you to locate the beginning of any recording made on the VCR.

Recording an INDEX mark

The Index Search function automatically records an INDEX mark on the tape whenever a recording is initiated.

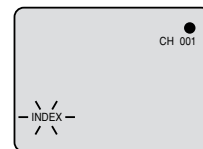

Index search

Press **INDEX +** or **-** during stop or play mode.

For Succeeding programs: Press **INDEX +**.

For Preceding programs: Press **INDEX -**.

(As many as 9 index points can be accessed via this method.)

When the **INDEX +** or **-** is pressed, the unit starts searching the INDEX NO. selected and finds the portion, then playback starts automatically. To stop the Index Search, press **STOP**.



▶▶ or ◀◀ is displayed

INDEX NO. (up to 9)

Notes:

- When you record an INDEX mark at the very beginning of the tape, the mark may not be found.
- During INDEX search, the tape may stop and begin to play at a slightly different location.
- INDEX may not function properly with old or worn out video tapes.
- INDEX marks may not be found if it is extremely close to the point where the search began.
- In recording, if you stop recording temporarily, the INDEX mark is not recorded on the tape.

SQPB (S-VHS Quasi Playback)

You can playback video cassette tapes recorded in the S-VHS system. However, the picture will not have the high resolution of S-VHS system.

Note: You cannot record S-VHS video format with this VCR.

Playback (VCR)

Recording a TV program

Recording and viewing the same TV program.

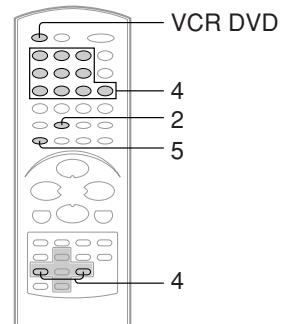

Recording a TV program

Preparation:

- Turn ON the TV and select to the corresponding video input.
- Press **VCR DVD** selector to select the VCR mode. (The VCR indicator will light.)

1 Load a cassette tape with the erase prevention tab intact.

The DVD/VCR will automatically turn on.

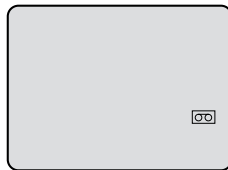
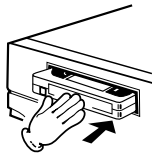

2 Press SP/SLP to select the desired tape speed SP or SLP.

The tape counter and "SP" or "SLP" will appear on the screen for about 4 seconds.

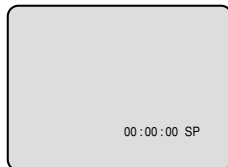

3 Select "TV" or "CATV" to the appropriate position [27].

TV - VHF/UHF channels
CATV - CABLE TV channels

4 Press Number buttons or CH +/- to select the channel to be recorded.

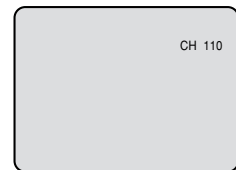
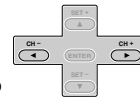

TV mode direct channel selection:

All channels can be instantly selected by using two buttons. (for example, to select channel 2, press "0", then "2". If you press only "2", channel selection will be delayed for two seconds.) For channels 10 and above, press the 2 digits in order.

CATV mode direct channel selection:

1-9 Press **0** twice and then **1-9** as required.
Example: To select "2", Press **002**.

10-12 Press **0** first and then the remaining 2 digits in order from left to right.

Example: Press **012** for "12".

13-99 Press 2 digits in order.

Example: Press **22** for "22".

100-125 Press the 3 digits in order.

Example: Press **110** for "110".

VHF/UHF/CATV CHANNELS

TV	CATV
VHF 2-13	VHF 2-13
UHF 14-69	STD/HRC/IRC 14-36 (A) (W) 37-59 (AA) (WW) 60-85 (AAA) (ZZZ) 86-94 (86) (94) 95-99 (A-5) (A-1) 100-125 (100)(125) 01 (5A)

5 Press REC/OTR.

"●" will appear on the screen for about 4 seconds and "REC" will appear on the display window.

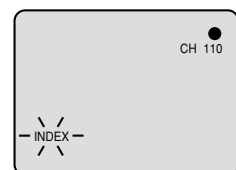

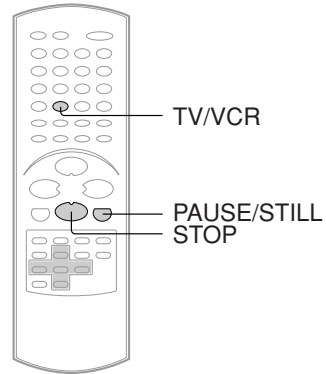

To stop recording

Press STOP to stop recording.

"■" will appear on screen for about 4 seconds.

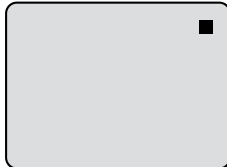

■ Auto Rewind feature

This VCR will automatically rewind the tape when the tape has ended (except during OTR and timer recording). It will also eject the tape.

To stop recording temporarily

Press PAUSE/STILL to avoid recording unwanted material. Press again to continue the recording.

"●||" will appear on screen for about 4 seconds.

PAUSE/STILL



Notes:

- The pause function will be released after 5 minutes to prevent damage to the tape or the VCR. The VCR will change to the STOP mode.
- You can select a recording channel in the recording pause mode.

Recording one program while watching another

While the VCR is recording, select your desired channel on the TV.

When a TV is connected with an antenna cable only, press TV/VCR to select the TV position.

The "VCR" display will go off and recording will continue. Select the TV channel you want to watch by using the TV channel selector.

Note:

Some CATV hookups do not permit viewing one channel while recording another. See pages [16](#) and [17](#).

Recording (VCR)

One-touch Timer Recording (OTR)

The One-touch Timer Recording feature provides a simple and convenient way to make a timed recording.

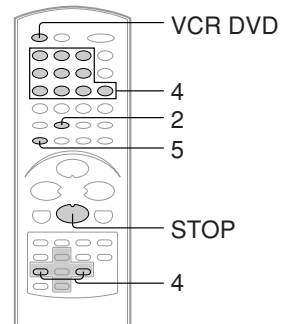

One-touch Timer Recording (OTR)

Preparation:

- Turn ON the TV and select to the corresponding video input.
- Press **VCR DVD** selector to select the VCR mode. (The VCR indicator will light.)

Example: One-touch Timer Recording for 30 minutes.

1 Load a cassette tape with the erase prevention tab intact.

The VCR will automatically turn on.

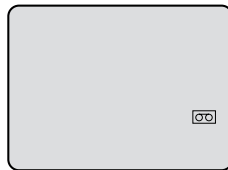
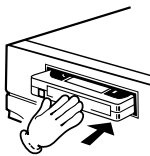

2 Press SP/SLP to select the desired tape speed SP or SLP.

The tape counter and "SP" or "SLP" will appear on the screen for about 4 seconds.

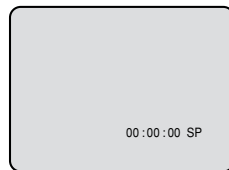

3 Set "TV" or "CATV" option to the appropriate position [27].

TV - VHF/UHF channels
CATV - CABLE TV channels

4 Press Number buttons or CH +/- to select the channel to be recorded.

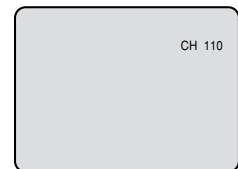
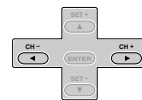
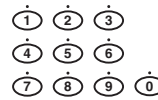

5 Press REC/OTR. Recording begins. Press the button again to stop recording after 30 minutes. Each additional press of REC/OTR will increase recording time as shown in the chart below, up to a maximum of 6 hours.

The OTR and recording time will appear on the screen for about 4 seconds. And, "●" will appear on the display.

Press	Recording time	Press	Recording time
once	NORMAL REC	6 times	3:00
twice	0:30	7 times	4:00
3 times	1:00	8 times	5:00
4 times	1:30	9 times	6:00
5 times	2:00	10 times	NORMAL REC

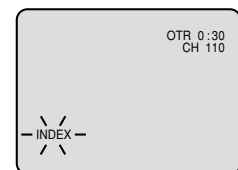

To cancel OTR

Press **STOP** or turn off the power.



"■" will appear on screen for about 4 seconds.

Note:

If you wish to watch the DVD playback during OTR or standard recording, press **VCR DVD** selector to change to DVD mode and perform the DVD playback [43].



Timer recording

Timer recording can be programmed on-screen with the remote control. The built-in timer allows automatic unattended recording of up to 8 programs within 1 month.

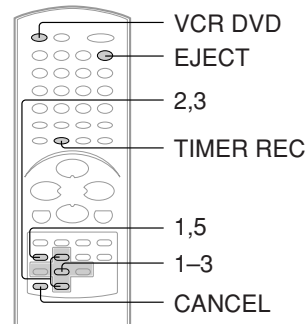

Timer recording

Preparation:

- Press **VCR DVD** selector to select the VCR mode.
- Load a cassette tape with the erase prevention tab intact.
- Check the time and date are correct [24].

Example: Program a timer recording for the 26th day, channel 125 (CATV), 11:00 - 11:30 PM on timer program number 1 (Tape speed: SLP).

1 Press **VCR MENU**. Select “**TIMER REC SET**”, then press **ENTER**.

MENU	ON	▶	OFF
TIMER REC SET	ON	▶	OFF
AUTO REPEAT	ON	▶	OFF
SAP	ON	▶	OFF
CH SETUP	ON	▶	OFF
SYSTEM SETUP	ON	▶	OFF

(+/-/ENTER/MENU)

2 Press **SET +** or **-** to select one of the program line, then press **ENTER**.

DATE	START	END	CH
26(SU)	11:00PM	11:30PM	125
---	---	---	---
---	---	---	---
---	---	---	---
---	---	---	---
---	---	---	---

(+/-/ENTER/CANCEL/MENU)

3 Press **SET +** or **-** to select the date, then press **ENTER**.

DATE	START	END	CH
26(SU)	---	---	---
---	---	---	---
---	---	---	---
---	---	---	---
---	---	---	---
---	---	---	---

(+/-/ENTER/CANCEL/MENU)

4 Set the start time, end time, channel and tape speed as in step 3.

DATE	START	END	CH	T
26(SU)	11:00PM	11:30PM	125	SLP
---	---	---	---	---
---	---	---	---	---
---	---	---	---	---
---	---	---	---	---
---	---	---	---	---

(+/-/ENTER/CANCEL/MENU)

Notes:

- Press **CANCEL** to move cursor backward for correction.
- To record from external source set the channel to “L1” or “L2”.

5 To enter other programs, repeat step 2 through 4.



- To return to the normal screen, press **VCR MENU** twice.

DATE	START	END	CH
26(SU)	11:00PM	11:30PM	125
---	---	---	---
---	---	---	---
---	---	---	---
---	---	---	---
---	---	---	---

(+/-/ENTER/CANCEL/MENU)

6 Press **TIMER REC**. The timer symbol ([]) will appear on the display and the VCR stands by for recording.



At the same time, VCR mode will change to DVD mode automatically. You can use DVD even if the VCR is in the timer recording mode. If you do not use the DVD, turn the power off.

Notes:

- The timer recording will start at 5 seconds before the time you predetermined.
- If the timer symbol ([]) does not appear on the display in spite of the pressing of **TIMER REC**, the cassette may not have been loaded. [29]
- If the cassette is ejected in spite of the pressing of **TIMER REC**, the erase prevention tab of the cassette may have been removed. [29]

Notes:

- If the timer symbol ([]) blinks when the timer recording ended, the TV program has not been completely recorded because of an insufficient tape length. Press **TIMER REC** to cancel the timer program or press **EJECT** to remove the cassette tape.
- During timer recording standby mode, the VCR mode cannot be operated. To use the VCR, press **TIMER REC** at first, then press **VCR DVD** selector to change to VCR mode. After you use the VCR, press **TIMER REC** again to put the VCR into timer recording standby mode.
- If you press **TIMER REC** during timer recording, the recording operation will be interrupted. If you press **TIMER REC** again within the programmed time, the recording operation will start again.
- After a power failure or disconnection of the power plug, all programmed recording settings and time display will be lost upon resumption of power. In this case, reset the clock [24] and reprogram any timer recording.

Recording (VCR)

Timer recording (continued)

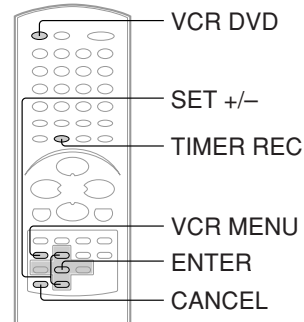

To set daily/weekly timer

Weekly (e.g. WKL-TU: each Tuesday) or daily (e.g. MO-SA: Monday to Saturday) Timer recording

Follow the procedure of timer recording on the previous page. At step 3 press **SET +** or **-** repeatedly until the desired setting appears. Then press **ENTER**.

When you press **SET -** repeatedly, the DATE indicator will change as follows, in this case the day is Friday.

The current day (Friday) → SU-SA (Sunday to Saturday)

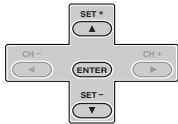
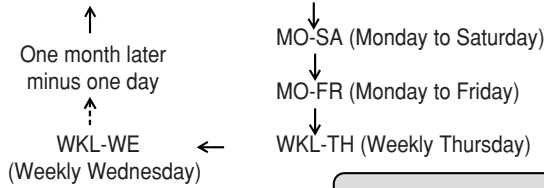

DATE	START	END	CH
WKL-WE	---	---	---
---	---	---	---
---	---	---	---
---	---	---	---
---	---	---	---
---	---	---	---
---	---	---	---
---	---	---	---
---	---	---	---

(+/-/ENTER/CANCEL/MENU)

To confirm or cancel a program

1 If the Timer has been activated, press **TIMER REC** to deactivate the Timer.

The timer symbol (☐) will disappear. Then press **VCR DVD** selector to change to VCR mode.



2 To confirm Timer program:

At step 1 on the previous page select "TIMER REC SET" and press **ENTER**. The timer program list will appear on the screen.

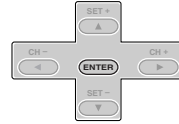

DATE	START	END	CH
26(SU)	11:00PM	11:30PM	125SLP
---	---	---	---
---	---	---	---
---	---	---	---
---	---	---	---
---	---	---	---
---	---	---	---
---	---	---	---
---	---	---	---

(+/-/ENTER/CANCEL/MENU)

If the programs overlap another

Do not overlap timer programs as portions of the conflicting programs will be lost. The first recording time has priority over the next recording time as shown in the diagram below.

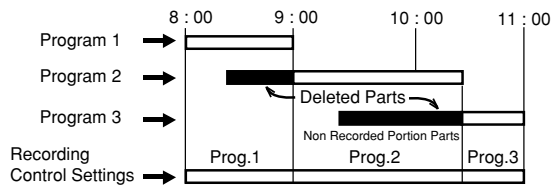

- Notes:**
- The daily/weekly recording can be made continuously until the recording is canceled or the tape reaches the end.
 - During timer recording the automatic rewinding mechanism does not function.

3 To cancel Timer program:

Press **SET +** or **-** to select the unwanted program, then press **CANCEL** to cancel the program.

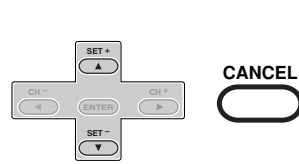

DATE	START	END	CH
---	---	---	---
---	---	---	---
---	---	---	---
---	---	---	---
---	---	---	---
---	---	---	---
---	---	---	---
---	---	---	---
---	---	---	---

(+/-/ENTER/CANCEL/MENU)

4 Press **VCR MENU** repeatedly until the menu screen is cleared.



- Notes:**
- If there are other timer record programs remaining, **TIMER REC** must be pressed to reactivate the timer, otherwise the remaining timer record programs will be ignored.
 - You cannot confirm the Timer program during timer recording operation.
 - You can correct or cancel a programmed setting in program confirm mode.

Stereo recording and playback / Second Audio Program (SAP)

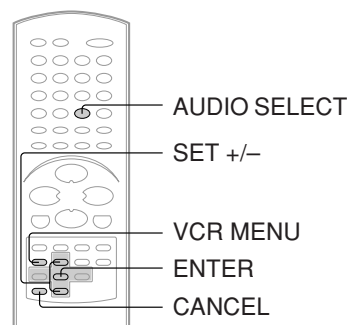

Stereo recording and playback

The VHS Hi-Fi audio system permits high fidelity recording of MTS STEREO TV broadcasts.

When a MTS STEREO broadcast is received, "STEREO" will appear on the screen for about 4 seconds and the program can be viewed or recorded in stereo. The Hi-Fi stereo recording procedure is the same as for normal recordings.

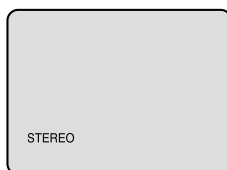

Note:

When using a CATV system, stereo TV programs may be transmitted over a mono cable channel. In this case "STEREO" will not appear and the sound will be in mono.

AUDIO SELECT
AUDIO



Output selection

When viewing an MTS stereo TV program, or playing a prerecorded VHS Hi-Fi stereo videotape, press **AUDIO SELECT** to select how the audio will be heard through the speakers. Normally set to the Hi-Fi stereo position, this button can be set to the MONO position if the stereo broadcast or videotape audio is of poor quality. The "R" and "L" positions allow the audio from the Right or Left Hi-Fi channel to be heard over both TV speakers. This button has no effect when viewing a MONO videotape or TV program. Each time when you press the button, OUTPUT SELECTION display appears on the screen for several seconds. Refer to the chart below.

OUTPUT SELECTION	SOUND HEARD ON BOTH SPEAKERS
STEREO	STEREO
L CH	LEFT CHANNEL AUDIO
R CH	RIGHT CHANNEL AUDIO
MONO	MONO

Second Audio Program (SAP)

Your DVD/VCR is fitted with a SAP broadcast system which enables you to switch to a second audio program when viewing a selected channel. This function applies only when the program is broadcast in multi-languages through the SAP broadcast system.

1 Press VCR MENU. Then press SET + or - to select "SAP".

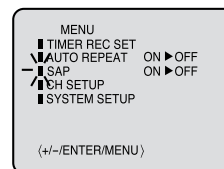
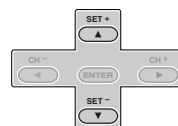

2 Press ENTER to select "ON".

Then press **VCR MENU** until the menu screen is cleared.

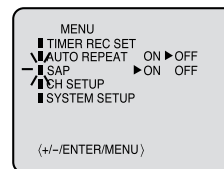
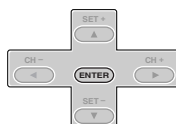

Listening to SAP

When the VCR is turned on or a channel selection is made, make certain the letters "SAP" appears on the screen for about 4 seconds. This means that the "Second Audio Program" broadcasting is available.

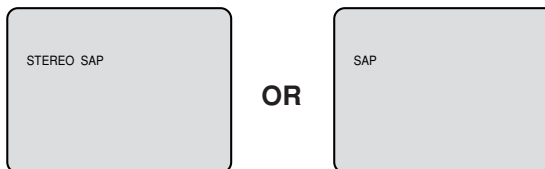

Notes:

- When playing back a tape that is not recorded in Hi-Fi stereo mode, the audio will automatically be monaural.
- When listening to a VHS Hi-Fi video tape or MTS broadcast through the VHF/UHF jack (Audio/Video cable not connected), the sound will be monaural.

Other functions (VCR)

Duplicating a video tape

If you connect the DVD/VCR to another VCR or Camcorder, you can duplicate a previously recorded tape. Make all connections before turning on the power.

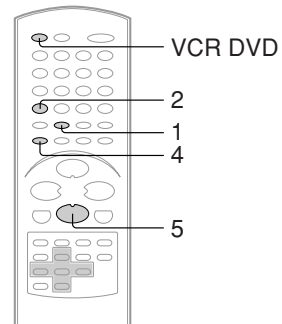

Duplicating a video tape

Preparation:

- Turn ON the TV and select the corresponding video input.
- Press **VCR DVD** selector to select the VCR mode. (The VCR indicator will light.)
- Load a cassette tape with the erase prevention tab intact.
- Load a previously recorded tape into the playback VCR or Camcorder.

1 Press SP/SLP to select the desired tape speed SP or SLP.



It is recommended that you set the tape speed to the SP mode on the recording VCR for best results.

2 Press INPUT SELECT once or twice to select AUDIO/VIDEO input position.

"L1" or "L2" will appear in the display.



L1: on the rear panel
L2: on the front panel

3 Press PLAY on the playback VCR or Camcorder.

4 Press REC/OTR on the recording VCR.

The duplicating process begins.



5 Press STOP after duplicating a video tape.



Connection with second VCR

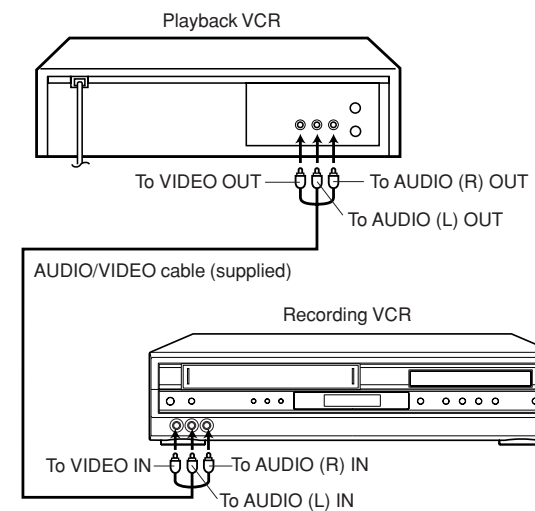

Connection with Camcorder

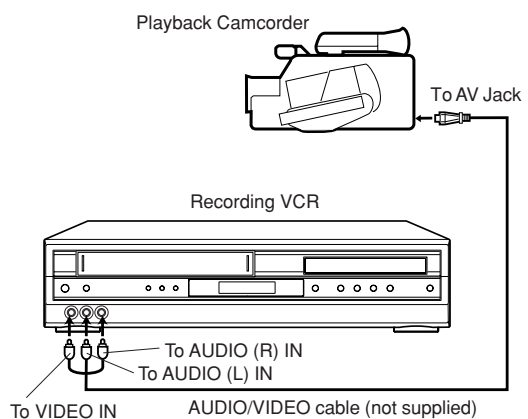

For duplicating a previously recorded tape from a camcorder, follow the camcorder manufacturer's instructions. A typical camcorder dubbing hookup is shown above.



Recording a DVD/CD disc

You can record disc material in DVD, Audio CD, etc. onto a Video tape with this DVD/VCR.

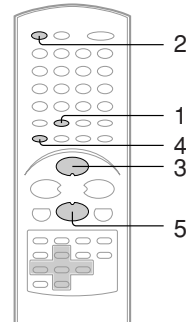

Duplicating a DVD or CD disc

Preparation:

- Turn ON the TV and select the corresponding video input.
- Press **VCR DVD** selector to select the VCR mode. (The VCR indicator will light.)
- Load a cassette tape with the erase prevention tab intact.
- Load a DVD/CD disc.

1 Press SP/SLP to select the desired tape speed SP or SLP.

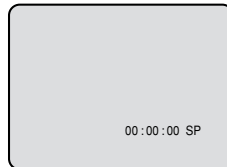

2 Press VCR DVD selector to select the DVD mode. The DVD indicator will light.



3 Press PLAY to start playback.



4 Press REC/OTR to start recording.



The DVD/VCR will change to the VCR mode automatically and the playback picture or sound will be duplicated on the video cassette tape.

5 Press STOP if you finish recording.



If you wish to stop a DVD/CD disc, press **VCR DVD** selector to change the DVD mode, then press **STOP**.

Notes:

- You may not be able to record the beginning of the disc. Begin VCR recording once program playback commences on the DVD.
- When the scanning mode is set to the progressive mode, you cannot duplicate a disc material onto a video tape. When **REC/OTR** is pressed, the PROGRESSIVE indicator "P" on the display window will flash and "Please Set P Off" will appear on the screen.
- You can not record discs encoded with copy guard function. The following icon and text will show up on the TV screen.



DISC IS COPY PROTECTED

Other functions (VCR)

Playing a disc

This section shows you the basics on how to play a disc.

CAUTION

Keep your fingers well clear of the disc tray as it is closing. Neglecting to do so may cause serious personal injury.

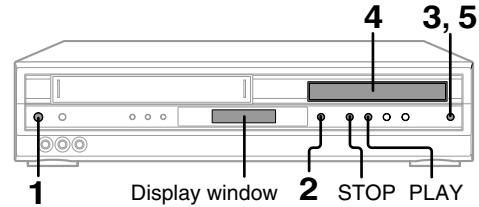

DVD VCD CD Basic playback

Preparations:

- When you want to view a disc, turn on the TV and select the corresponding video input connected to the DVD/VCR. This may include S-video or component video inputs which are exclusive to DVD playback.
- When you want to enjoy the sound of discs from the audio system, turn on the audio system and select the input connected to the DVD/VCR.

1 Press ON/STANDBY (I / ⏻).
 ON/STANDBY I / ⏻ The DVD/VCR turns on.

2 Press VCR/DVD SELECT to select the DVD mode.
 VCR/DVD SELECT The DVD indicator will light.

3 Press OPEN/CLOSE.
 OPEN/CLOSE The disc tray opens.

4 Place the disc on the disc tray.
 With the playback side down

- There are two different disc sizes. Place the disc in the correct guide on the disc tray. If the disc is out of the guide, it may damage the disc and cause the DVD/VCR to malfunction.
- Do not place a disc which is unplayable in this DVD/VCR.

5 Press OPEN/CLOSE or PLAY on the unit.
 OPEN/CLOSE OR PLAY The disc tray closes automatically. On the TV-screen, "▲" changes to "Reading" and then playback commences.

- A menu screen will appear on the TV screen, if the disc has a menu feature.



6 Press ▲/▼ or ◀/▶ to select title.

7 Press ENTER.
 • Title is selected and play commences.

8 Press STOP to end playback.
 STOP The unit records the stopped point, depending on the disc. "■" appears on the screen. Press PLAY to resume playback (from the scene point).
 • If you press STOP again or unload the disc ("■" appears on the screen.), the unit will clear the stopped point.

■ To start playback in the stop mode

Press **PLAY**.

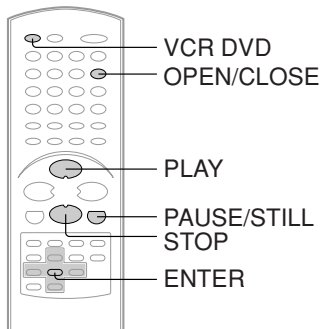

■ To obtain a higher quality picture

Occasionally, some picture noise not usually visible during a normal broadcast may appear on the TV screen while playing a DVD video disc because the high resolution pictures on these discs include a lot of information. While the amount of noise depends on the TV you use with this DVD/VCR, you should generally reduce the sharpness adjustment on your TV when viewing DVD video discs.

■ About

The icons on the heading bar show the playable discs for the function described under that heading.

: You can use this function with DVD video discs.

: You can use this function with Video CDs.

: You can use this function with Audio CDs and CD-R/RW CDs.

■ To pause playback (still mode)

Press **PAUSE/STILL** during playback.

PAUSE/STILL



To resume normal playback, press the **PLAY** button.

- The sound is muted during still mode.

■ To stop playback

Press **STOP**.



■ To remove the disc

Press **OPEN/CLOSE**.

OPEN/CLOSE



Remove the disc after the disc tray opens completely.

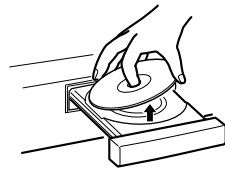

Be sure to press the **OPEN/CLOSE** button to close the disc tray after you remove the disc.

■ Playing a Disc while the VCR section is recording or standing by for timer recording

- 1) Start to record.
Follow steps 1~5 on page 34.
• If the DVD/VCR is standing by for recording, turn on the DVD/VCR.
- 2) Press **VCR DVD** selector to select DVD mode. The DVD indicator will light.
- 3) Play a disc.
Follow steps 3 ~ 5 on page 42.
• Press **PLAY** if the DVD/VCR does not start to play a disc automatically.
- 4) Stop to play.
Press **STOP** to stop play back a disc.

■ Screen saver function

The screen saver operates when you leave the unit in DVD stop mode for about five minutes. The screen will repeatedly get dark gradually and back to normal.

■ To turn off the PBC

Press number button 1 in the stop mode, then press **ENTER**.

Notes:

- If a non-compatible disc is loaded, "Incorrect Disc", "Region Code Error" or "Parental Error" will appear on the TV screen according to the type of loaded disc. In this case, check your disc again (See pages 8 and 61).
- Some discs may take a minute or so to start playback.
- When you set a single-faced disc label downwards (ie. the wrong way up) and press the **OPEN/CLOSE** button or the **PLAY** button on the unit, "Reading" will appear on the display for 30 seconds and then "Incorrect Disc" will continue to be displayed.
- Some discs may not work the resuming facility.
- Resuming cannot function when you play a PBC-featured Video CD while the PBC is on. To turn off the PBC, see above.
- Some playback operations of DVDs may be intentionally fixed by software producers. Since this unit plays DVDs according to the disc contents the software producers designed, some playback features may not be available. Also refer to the instructions supplied with the DVDs.
- Do not move the DVD/VCR during playback. Doing so may damage the disc.
- Use the **OPEN/CLOSE** button to open and close the disc tray. Do not push the disc tray while it is moving. Doing so may cause the DVD/VCR to malfunction.
- Do not push up on the disc tray or put any objects other than discs on the disc tray. Doing so may cause the DVD/VCR to malfunction.
- In many instances, a menu screen will appear after playback of a movie is completed. Prolonged display of an on-screen menu may damage your television set, permanently etching that image onto its screen. To avoid this, be sure to press the **ON/STANDBY** () button on your remote control once the movie is completed.
- There may be a slight delay between you pressing the button and the function activating.



Playing a disc (continued)

You can play discs at various speeds.

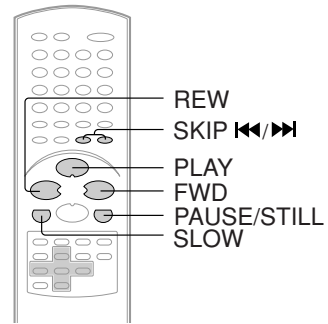

DVD VCD CD Playing in fast reverse or fast forward directions

Press REW or FWD during playback.



REW: Fast reverse playback
FWD: Fast forward playback

Each time you press the REW or FWD button, the playback speed changes.

To resume normal playback

Press **PLAY**.



Notes:

- The DVD/VCR mutes sound and subtitles during reverse and forward scan of DVD video discs. However, the DVD/VCR plays sound during fast forward or fast reverse play of audio CDs.
- The playback speed may differ depending on the disc.

DVD VCD Playing frame by frame

Press PAUSE/STILL during still playback.



Each time you press the PAUSE/STILL button, the picture advances one frame.

To resume normal playback

Press **PLAY**.



Note:

The sound is muted during frame by frame playback.

DVD VCD Playing in slow-motion

Press SLOW during playback.



Each time you press the SLOW button, the slow-motion speed changes.

To resume normal playback

Press **PLAY**.



Note:

The sound is muted during slow-motion playback.

DVD VCD CD Locating a chapter or track

Press SKIP I◀◀ or ▶▶I repeatedly to display the chapter or track number you want.

Playback starts from the selected chapter or track.



To locate succeeding chapters or tracks.



Playback starts from the beginning of the current chapter or track. When you press twice in quick successions, playback starts from the beginning of the preceding chapter or track.

Notes:

- A "Prohibition" symbol  may appear at the upper left of the screen. This symbol means either the feature you tried is not available on the disc, or the DVD/VCR can not access the feature at this time. This does not indicate a problem with the DVD/VCR.
- The unit is capable of holding a still video image or On screen display image on your television screen indefinitely. If you leave the still video image or On screen display image displayed on your TV for an extended period of time, you risk permanent damage to your television screen. Projection televisions are very susceptible.

MP3/WMA/JPEG playback

This player can playback the MP3/WMA/JPEG-data which has been recorded on CD-R or CD-RW. To produce the MP3/WMA/JPEG-data, you need a Windows-PC with CD-ROM drive and a MP3/WMA/JPEG-encoding Software (not supplied).
The Apple-HFS-System can not be played.

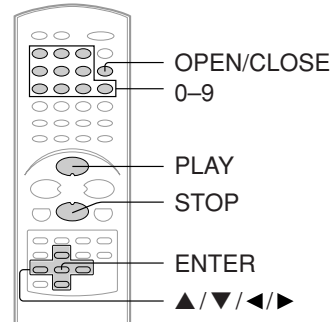

CD MP3/WMA playback

1 Press OPEN/CLOSE.
OPEN/CLOSE The disc tray will open. Place a disc on which MP3 or WMA files have been recorded onto the tray.

2 Press OPEN/CLOSE or PLAY.
OPEN/CLOSE The disc tray closes automatically. On the TV-screen, "Reading" will appear. Reading will take as much time as the number of file.

PLAY

3 A file menu screen will appear on the TV screen.
Press ◀ or ▶ to select folder.

4 Press ▲/▼ or ◀/▶ or Number keys to select the desired file, then press ENTER.
 The file is selected and play commences.

• In case the folder includes more than 15 tracks, press ◀ or ▶ to display next file list.

• When **PLAY** has been pressed after displaying the file menu, or when the disc tray has been closed after pressing **PLAY** in step 2, playback begins automatically starting from the first file. In this case, if the first file is an MP3/WMA file, only MP3/WMA files are played back in order. If the first file is a JPEG file, the first JPEG file is played back.

5 Press STOP to end playback.

PLAY

STOP

- The unit records the stopped point. "■" appears on the screen. Press **PLAY** to resume playback (from the scene point).
- If you press **STOP** again or unload the disc, the unit will clear the stopped point.

MP3/WMA/JPEG CD Information

Limitations on MP3/WMA/JPEG CD playback

- MP3/WMA/JPEG CD is the disc that is standardized by ISO9660, its file name must include 3-digits extension letters, "mp3", "wma", "jpg".
- The directory and file names of the MP3/WMA/JPEG CD must be correspond to the ISO standardized files.
- This unit can read 200 files per disc. If a disc has more than 200 files, it reads up to 200 files, the remaining files will be omitted.
- The unit is able to recognize up to a maximum of 50 directories per disc.
- MP3/WMA CDs cannot be used for playback for the purpose of recording.
- If the CD has both audio tracks and MP3/WMA/JPEG files, only audio tracks are played.
- It may take more than one minute for this unit to read MP3/WMA/JPEG files depending on its structure.
- Music recorded by "Joliet Recording Specification" can be played back, the file name is displayed (within 16 letters) on the screen. Long file names will be condensed.
- The music files recorded by "Hierarchical File System" (HFS) cannot be played.
- The unit can playback baseline and progressive JPEG files.

Limitations on display

- The maximum number for display is 16 letters. Available letters for display are the following: capital or small alphabets of A through Z, numbers of 0 through 9, and _ (under score).
- Other letters than those above are replaced in hyphen.

Notes on MP3/WMA/JPEG files

To playback MP3/WMA/JPEG CD in the recorded order,

- Use MP3/WMA/JPEG software that records data alphabetically or numerically.
- Name each file including two-digit or three-digit number (e.g. "01" "02" or "001" "002").
- Refrain from making too many sub-folders.

WMA disc compatibility with this player is limited as follows:

- Sampling Frequency: within 32 -- 48 kHz
- Bit Rate: within 48 -- 192kbps.
Mono WMA files and WMA files (under 48kbps) cannot be played back on this player.

CAUTION:

- Some MP3/WMA/JPEG CDs can not be played back depending on the recording conditions.
- The CD-R/RW that has no music data or non-MP3/WMA/JPEG files can not be played back.

Advanced playback (DVD)

MP3/WMA/JPEG playback (continued)

You can select your desired JPEG file on the file menu and picture menu. The selected JPEG file is automatically adjusted to the TV screen. (When the aspect ratio of the JPEG file is different to your TV screen, the black bar will appear at the top and bottom, or the both sides of the TV screen.)

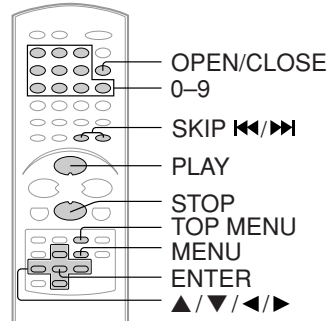

CD JPEG CD playback

1 Press OPEN/CLOSE.
 The disc tray will open. Place a disc on which JPEG files have been recorded onto the tray.

2 Press OPEN/CLOSE or PLAY.
 The disc tray closes automatically. On the TV-screen, "Reading" will appear. Reading will take as much time as the number of file.

3 A file menu screen will appear on the TV screen. Press ◀ or ▶ to select folder.

4 Press ▲/▼ or ◀/▶ or Number keys to select the desired file.

To display a picture menu, press MENU. (To return to a file menu, press TOP MENU.)
 Press ▲/▼ or ◀/▶ to select the desired file.

- To display next list, press **SKIP** ►►► or ◀◀◀.
- When **PLAY** has been pressed after displaying the file menu, or when the disc tray has been closed after pressing **PLAY** in step 2, playback begins automatically starting from the first file. In this case, if the first file is a JPEG file, the first JPEG file is played back. If the first file is an MP3/WMA file, only MP3/WMA files are played back in order.

5 Press ENTER.
 The selected picture appears on the TV screen.

6 Press STOP to end playback.
 The file menu appears on the TV screen. If you want to watch the other file, repeat steps 4~5.

Notes:

- The picture menu is displayed when the FUJICOLOR CD or the Kodak Picture CD are played. To display the file menu press **TOP MENU**.
- During MP3/WMA/JPEG-Playback, you can not use SEARCH, A-B Repeat functions.
- You can use Repeat (Track or All), Random functions and Program playback for MP3/WMA/JPEG CD Playback. (See pages 52 and 53.)
- In the case of a CD containing a mixture of MP3, WMA and JPEG files, the files are played back by selecting them from the file menu.

File menu information

: Indicates MP3 file
 : Indicates WMA file
 : Indicates JPEG file

Microsoft, Windows Media, and Windows Logo are trademarks or registered trademarks of Microsoft Corporation in both the United States and other countries.

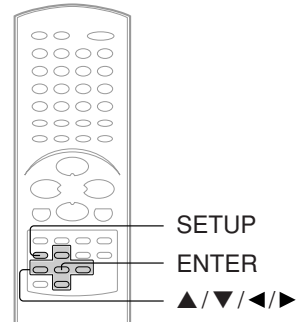

CD Setting the JPEG Interval

You can continuously play back all JPEG files automatically.
After the setting below, start playing the disc on which JPEG files have been recorded.

1 Press **SETUP** in the stop mode. Press **◀** or **▶** to select "Picture", then press **ENTER**.

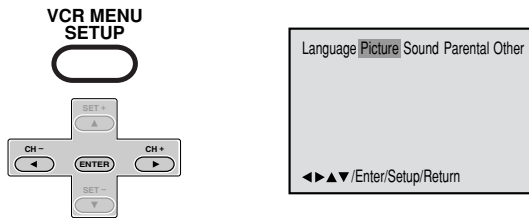

4 To make **SETUP** screen disappear, press **SETUP**.



2 Press **▲** or **▼** to select "JPEG Interval".

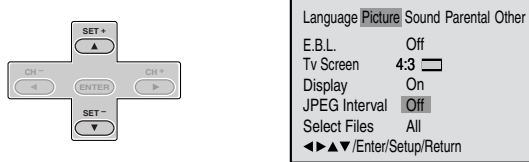

3 Press **ENTER** or **◀/▶** to select your desired time.

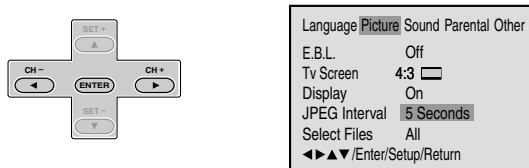

Off:

Plays back one file at a time.

5 Seconds:

Plays back images in the form of a slide show at 5 second intervals.

10 Seconds:

Plays back images in the form of a slide show at 10 second intervals.

15 Seconds:

Plays back images in the form of a slide show in 15 second intervals.

Advanced playback (DVD)



MP3/WMA/JPEG playback (continued)

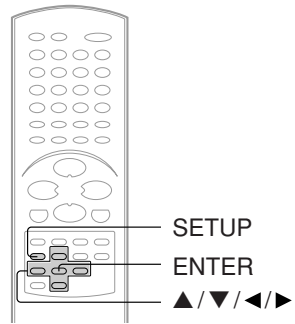

CD Setting the Select Files

When playing back a CD containing a mixture of MP3, WMA and JPEG files, only MP3/WMA or JPEG files can be displayed on the file menu.

1 Press **SETUP** in the stop mode. Press **◀** or **▶** to select "Picture", then press **ENTER**.

VCR MENU
SETUP

Language **Picture** Sound Parental Other

◀▶▲▼/Enter/Setup/Return

4 To make **SETUP** screen disappear, press **SETUP**.

VCR MENU
SETUP

2 Press **▲** or **▼** to select "Select Files".

Language **Picture** Sound Parental Other

E.B.L. Off

Tv Screen 4:3

Display On

JPEG Interval Off

Select Files **All**

◀▶▲▼/Enter/Setup/Return

3 Press **ENTER** or **◀/▶** to select your desired file type.

Language **Picture** Sound Parental Other

E.B.L. Off

Tv Screen 4:3

Display On

JPEG Interval Off

Select Files **Pictures Only**

◀▶▲▼/Enter/Setup/Return

- All:**
Displays all files.
- Music Only:**
Displays only MP3/WMA files.
- Pictures Only:**
Displays only JPEG files.



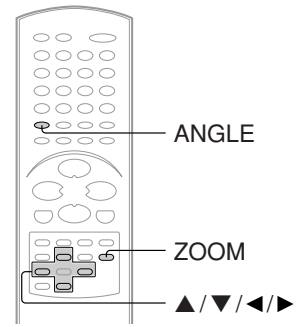

CD Zooming (JPEG CD)

This unit will allow you to zoom in on the JPEG image.

1 Press ZOOM during playback.

CM SKIP ZOOM  Enlarged JPEG images are displayed. You can make the images even larger by repeatedly pressing **ZOOM**.

2 Press ▲ / ▼ / ◀ / ▶ to view a different part of the frame.

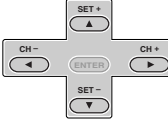
 You may move the frame from the centre position to UP, DOWN, LEFT or RIGHT direction.

3 In the zoom mode press ZOOM repeatedly to return to a 1:1 view (Q Off).

CM SKIP ZOOM 

Q 1 → Q 2

↑ ↓

Q Off ← Q 3

CD Changing angles (JPEG CD)

You can display JPEG images rotating at 90 degree intervals.

1 Press ANGLE during playback.

Images are rotated 90 degrees to the right.

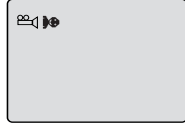
COUNTER RESET ANGLE  

2 Press ANGLE repeatedly until the desired angle is selected.

Pressing **ANGLE** four times returns the image to its original angle.

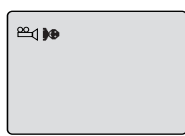
COUNTER RESET ANGLE  • Images are displayed at the same angle until the disc is removed.

Advanced playback (DVD)





Zooming/Locating desired scene

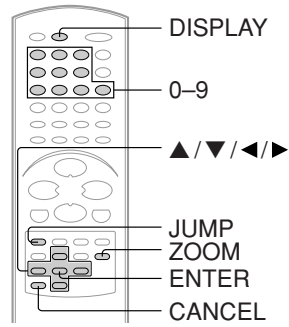

DVD VCD Zooming

This unit will allow you to zoom in on the frame image. You can then make selections by switching the position of the frame.

1 Press ZOOM during playback.

CM SKIP ZOOM



The centre part of the image will be zoomed in. Each press of **ZOOM** will change the ZOOM Q1 (x 1.3), Q2 (x 1.5) and Q3 (x 2.0).

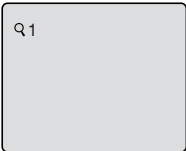

2 Press ▲ / ▼ / ◀ / ▶ to view a different part of the frame.

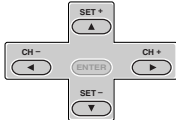

You may move the frame from the centre position to UP, DOWN, LEFT or RIGHT direction.

3 In the zoom mode press ZOOM repeatedly to return to a 1:1 view (Q Off).

CM SKIP ZOOM



- Notes:**
- You can select the Pause, Slow or Search playback in the zoom mode.
 - Some discs may not respond to zoom feature.

DVD VCD CD Locating desired scene

Use the title, chapter and time recorded on the disc to locate the desired point to play back. To check the title, chapter and time, press **DISPLAY**.

1 Press JUMP during playback or stop mode.

ZERO RETURN JUMP

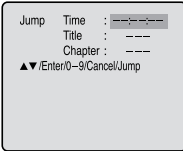

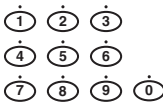

3 Press Numbered buttons (0-9) to change the number.

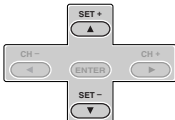

- If you input a wrong number, press **CANCEL**.
- Refer to the package supplied with the disc to check the numbers.

2 Press ▲ or ▼ to select the "Time", "Title" or "Chapter".



4 Press ENTER. Playback starts.

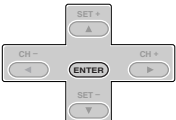

- When you change the title, playback starts from Chapter 1 of the selected title.
- Some discs may not work in the above operation.

Note: In case of the Video-CD playback with PBC, the JUMP does not work. To turn off PBC, see page 43.





Marking desired scenes

The unit stores the points that you want to watch again up to 3 points. You can resume playback from each scene.

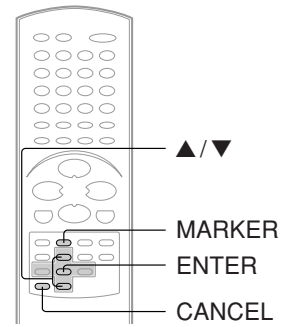

DVD VCD CD Marking the scenes

- 1** Press **MARKER** during playback.

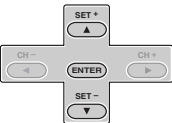

Marker 1 : **: **: **
 Marker 2 : **: **: **
 Marker 3 : **: **: **
 ▲▼/Enter/Cancel/Marker
- 2** Select the blank Marker using **▲** or **▼**. Then press **ENTER** at the desired scene.

 - Repeat this procedure to set the other 2 scenes.

Marker 1 : 00 : 27 : 54
 Marker 2 : **: **: **
 Marker 3 : **: **: **
 ▲▼/Enter/Cancel/Marker
- 3** Press **MARKER** to remove this display.

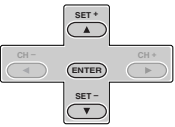

DVD VCD CD Returning to the scenes

- 1** Press **MARKER** during playback or stop mode.



Marker 1 : 00 : 27 : 54
 Marker 2 : 01 : 16 : 25
 Marker 3 : 02 : 08 : 31
 ▲▼/Enter/Cancel/Marker
- 2** Press **▲** or **▼** to select the Marker 1-3.

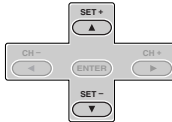

Marker 1 : 00 : 27 : 54
 Marker 2 : 01 : 16 : 25
 Marker 3 : 02 : 08 : 31
 ▲▼/Enter/Cancel/Marker
- 3** Press **ENTER**.

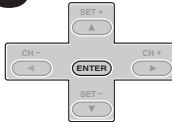

Playback starts from the marked scene.

■ **To cancel the Marker**
Follow the above steps 1~2, then press **CANCEL**.

Notes:

- Some discs may not work with the marking operation.
- The marking is canceled when you open the disc tray or turn the power off.
- Some subtitles recorded around the marker may fail to appear.

Advanced playback (DVD)

Repeat playback/A-B Repeat playback

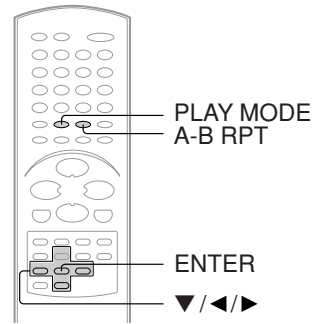

DVD VCD CD Repeat playback of Title, Chapter and Track

- Press **PLAY MODE** during playback or stop mode.

SP/SLP
PLAY MODE
- DVD
Press **◀/▶** or **ENTER** once or twice to select "Chapter" or "Title".

Repeat : Off ◀▶/Enter/Play Mode	Repeat : Chapter ◀▶/Enter/Play Mode	Repeat : Title ◀▶/Enter/Play Mode
------------------------------------	--	--------------------------------------

CD/VCD
Press **▼** to select "Repeat".
Press **◀/▶** or **ENTER** once or twice to select "Track" or "All".

Play Mode : Off Repeat : Off ◀▶/Enter/Play Mode	Play Mode : Off Repeat : Track ◀▶/Enter/Play Mode	Play Mode : Off Repeat : All ◀▶/Enter/Play Mode
---	---	---
- Press **PLAY MODE** again to make the screen disappear.
Press **PLAY** to start Repeat playback.
To resume normal playback, select Repeat "Off".

Note:
Some discs may not work with the repeat operation.

DVD VCD CD A-B Repeat playback

A-B repeat playback allows you to repeat material between two selected points.

- Press **A-B RPT** during playback.

A-B RPT

The start point is selected.
- Press **A-B RPT** again.

A-B RPT

The end point is selected. Playback starts at the point that you selected. Playback stops at the end point, returns to Point A automatically, then starts again.

To resume normal playback
Press **A-B RPT** again.

A-B RPT

"Off" appears on the screen.

- Notes:**
- In A-B repeat mode, subtitles near point A or B may not appear.
 - A-B Repeat playback is not available in multi-angle scenes.
 - A-B Repeat playback does not work when Repeat playback is on.
 - You may not be able to set A-B Repeat, depending on the scenes of the DVD.
 - A-B repeat does not work with an interactive DVD, MP3/WMA/JPEG CD and Video CD with PBC.



Program playback/Random playback (CD)

You can arrange the order of tracks on the disc.

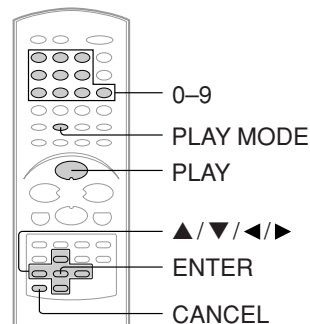

VCD CD Program playback

1 Press **PLAY MODE** in the stop mode.

SP/SLP
PLAY MODE



Play Mode	: Off
Repeat	: Off
◀▶▲▼/Enter/Play Mode	

2 Press **▲** or **▼** to select **Play Mode**, then press **◀/▶** or **ENTER** to select **"Program"**.

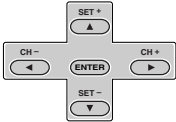

Play Mode	: Program		
Repeat	: Off		
1	4	7	10
2	5	8	11
3	6	9	12
[Clear] [Program Playback]			
◀▶▲▼/Enter/0-9/Cancel/Play Mode			

3 Press **▲/▼** or **◀/▶** to select the programming position. Use **Numbered buttons (0-9)** to input the **Track numbers**.

- To program others, repeat Step 3.
- If you input a wrong number, press **CANCEL**.

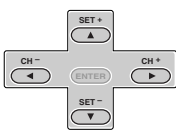

Play Mode	: Program			
Repeat	: Off			
1	9	4	7	10
2	3	5	8	11
3	1	6	9	12
[Clear] [Program Playback]				
◀▶▲▼/Enter/0-9/Cancel/Play Mode				

① ② ③
④ ⑤ ⑥
⑦ ⑧ ⑨ ⑩

4 Press **▲/▼** or **◀/▶** to select **"Program Playback"** and press **ENTER**.

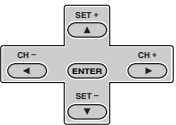

The programmes you selected will start to playback in the order.
To return to normal playback, select Play Mode: "Off".

Play Mode	: Program			
Repeat	: Off			
1	7	4	7	10
2	3	5	8	11
3	1	6	9	12
[Clear] [Program Playback]				
◀▶▲▼/Enter/0-9/Cancel/Play Mode				

To cancel program playback
Select **"Clear"** and press **ENTER**.

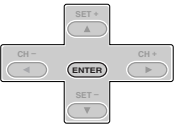

- The program is canceled when you open the disc tray or turn the power off.

Note:
In playing back the Video CD with PBC, you can not set Program playback.

VCD CD Random playback

1 Press **PLAY MODE** in the stop mode.

SP/SLP
PLAY MODE



2 Press **▲/▼** to select **Play Mode**, then press **◀/▶** to select **"Random"**.

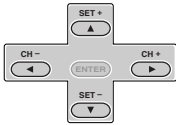

Play Mode	: Random
Repeat	: Off
◀▶▲▼/Enter/Play Mode	

3 Press **PLAY**.



The Random Playback will start.

Note:
In playing back the Video CD with PBC, you can not set Random playback.

Advanced playback (DVD)





Changing angles/Title selection/DVD menu

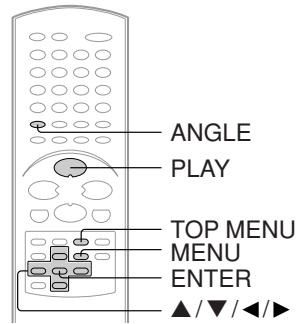

DVD Changing angles

When playing back a disc recorded with multi-angle facility, you can change the angle that you are viewing the scene from.

1 Press ANGLE during playback.
The current angle will appear.

COUNTER RESET ANGLE

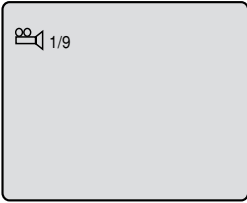
2 Press ANGLE repeatedly until the desired angle is selected.

COUNTER RESET ANGLE



Note:
Depending on the DVD, you may not be able to change the angles even if multi-angles are recorded on the DVD.

DVD Title selection

Two or more titles are recorded on some discs. If the title menu is recorded on the disc, you can select the desired title.

1 Press TOP MENU during playback.
Title menu appears on the screen.



TOP MENU

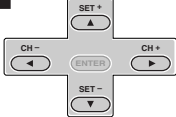

2 Press ▲/▼ or ◀/▶ to select the desired title.

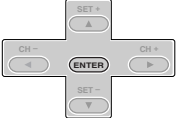

3 Press ENTER or PLAY.
The playback of the selected title will start.

Note:
Depending on the DVD, you may not be able to select the title. Depending on the DVD, a "title menu" may simply be called a "menu" or "title" in the instructions supplied with the disc.

DVD DVD menu

Some DVDs allow you to select the disc contents using the menu. When you play back these DVDs, you can select the subtitle language and sound-track language, etc. using the menu.

1 Press MENU during playback.
The DVD menu appears on the screen.

MENU



- Press **MENU** again to resume playback at the scene when you pressed **MENU**.

2 Press ▲/▼ or ◀/▶ to select the desired item.

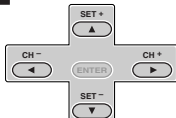

3 Press ENTER.
The menu continues to another screen. Repeat steps 2 and 3 to set the item completely.

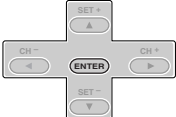

Note:
Depending on the DVD, you may not be able to resume playback from the scene point when you pressed **MENU**.



Changing soundtrack language/ Setting surround sound

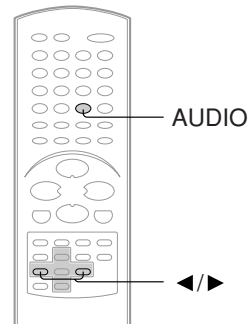

DVD VCD Changing soundtrack language

You can select the language when you play a multilingual disc.

1 Press AUDIO during playback.
AUDIO SELECT AUDIO The current soundtrack language will appear.



2/8 Fra Dolby Digital
Spatializer Off

2 Press AUDIO repeatedly until the desired language is selected.

AUDIO SELECT AUDIO The on-screen display will disappear after a few seconds.



1/8 Eng Dolby Digital
Spatializer Off

In case of Video CD playback

Audio type changes as follows each time you press AUDIO.

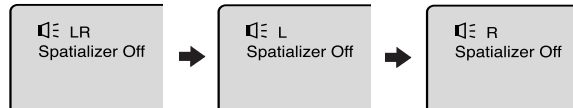

Notes:

- If the desired language is not heard after pressing the button several times, the language is not recorded on the disc.
- Changing soundtrack language is cancelled when you open the disc tray. The initial default language or available language will be heard if the disc is played back again.

DVD VCD CD Setting surround sound

This DVD/VCR equipped with a "SPATIALIZER VIRTUAL SURROUND". It can produce the effect of being in a cinema or a concert hall.

1 During disc playback press AUDIO.

AUDIO SELECT AUDIO



1/8 Eng Dolby Digital
Spatializer Off

2 Press ◀ or ▶ to select "On".

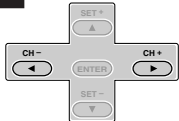

1/8 Eng Dolby Digital
Spatializer On

To cancel Surround mode:

Follow the left steps 1~2, then press ◀ or ▶ to select the "Off" position.

Note:

The "SPATIALIZER VIRTUAL SURROUND" is effective only for the sound of disc.

Spatializer® 3-Dimensional Sound Processing provided by Desper Products, Inc.

Certain audio features of this product manufactured under a license from Desper Products, Inc., Spatializer® and the circle-in-square device are trademarks owned by Desper Products, Inc.



Setting subtitles/Karaoke playback

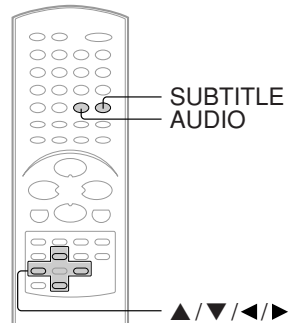

DVD Turning the subtitles on and off

When playing back a disc recorded with subtitles, you can turn the subtitles on or off.

Press SUBTITLE during playback until "Off" appears.

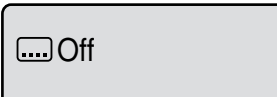



Note:
Depending on the DVD, you may not be able to turn the subtitles on even if they are recorded on it.
Depending on the DVD, you may not be able to turn the subtitles off.

DVD Changing the subtitle language

You can select the language when playing back a disc recorded with multi-lingual subtitles.

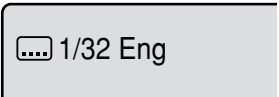
1 Press SUBTITLE repeatedly during playback until your desired language appears.

2 The on-screen display will disappear after a few seconds.

Notes:

- Changing subtitle language is cancelled when you open the disc tray.
- Depending on the DVD, you may not be able to change the subtitles even if multilingual subtitles are recorded on it. While playing the DVD, the subtitle may change when: -you open or close the disc tray -you change the title.
- In some cases, the subtitle language is not changed to the selected one immediately.

DVD Karaoke playback

You can turn the vocal on or off recorded on the DVD KARAOKE.

1 During DVD KARAOKE disc playback, press AUDIO.

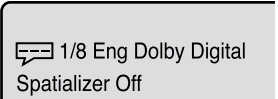

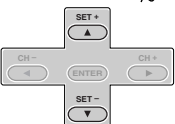
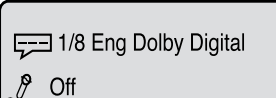

2 Press ▲ or ▼ until the KARAOKE symbol (🎤) appears.

- If you play non-Karaoke disc, the KARAOKE symbol (🎤) does not appear.

3 Press ◀ or ▶ to select "On" or "Off".

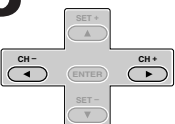

On : The primary vocal is output when it is recorded on the disc.
Off : The primary vocal is not output.

Notes:

- The vocal output feature is used during playback of Dolby Digital (multi-channel) recorded DVD KARAOKE discs. This feature allows you to turn off vocal audio tracks, or restore them for background accompaniment.
- When playing Karaoke, connect appropriate audio equipment such as an amplifier to the DVD/VCR.





E.B.L. (Enhanced Black Level)

To select the black level of playback pictures, set your preference and monitor's ability.

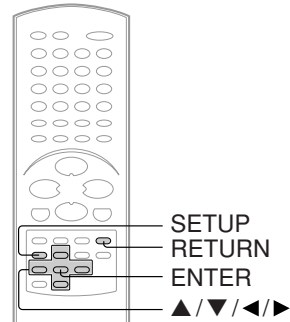

DVD Setting E.B.L.

1 Press **SETUP** in the stop mode or No Disc. Press **◀** or **▶** to select "Picture".

Language **Picture** Sound Parental Other

◀▶▲▼/Enter/Setup/Return

4 To make **SETUP** screen disappear, press **SETUP** or **RETURN** while the **SETUP** screen is being displayed.

2 Press **▼** or **ENTER**, then press **▲** or **▼** to select "E.B.L.".

Language **Picture** Sound Parental Other

E.B.L. **Off**

Tv Screen 4:3

Display On

JPEG Interval Off

Select Files All

◀▶▲▼/Enter/Setup/Return

3 Press **◀/▶** or **ENTER** to select "On" or "Off".

Language **Picture** Sound Parental Other

E.B.L. **On**

Tv Screen 4:3

Display On

JPEG Interval Off

Select Files All

◀▶▲▼/Enter/Setup/Return

On: Enhanced grey scale (0 IRE cut off)
Off: Standard grey scale (7.5 IRE cut off)

Function setup (DVD)



Setting the aspect ratio of TV screen

You can select the aspect ratio for your TV.
The following pages describe the setup/operation in DVD mode.

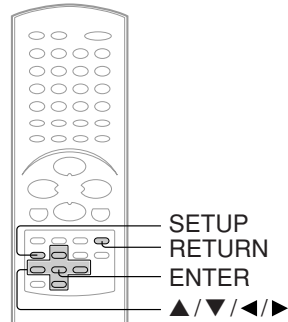

DVD Setting the aspect ratio of TV screen

1 Press **SETUP** in the stop mode or No Disc.
Press **◀** or **▶** to select "Picture".

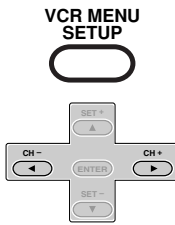
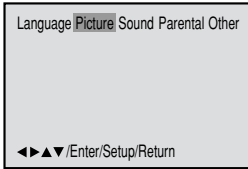
2 Press **▼** or **ENTER**, then press **▲** or **▼** to select "Tv Screen".

3 Press **▶** or **ENTER**.
Press **▲** or **▼** to select your desired screen type, then press **ENTER**.

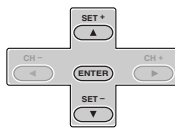
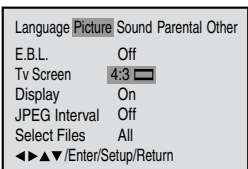
You have the following screen sizes to choose from:

4:3 **Letter box:**
Select this mode when connecting to a conventional TV. When playing back a wide screen-DVD disc, it displays the wide picture with black bands at the top and bottom of screen.

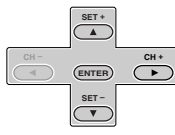
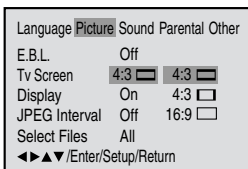
4:3 **Pan scan:**
It displays the wide picture on the whole screen with left and right edges automatically cut off.

16:9 **Wide:**
Select this mode when connecting to a wide-screen TV. A wide screen picture is displayed full size.

4 To make **SETUP** screen disappear, press **SETUP** or **RETURN** while the **SETUP** screen is being displayed.



Note:
If the DVD disc is not formatted in the pan & scan style, it displays 4:3 style.





Setting on screen display/Status display of disc

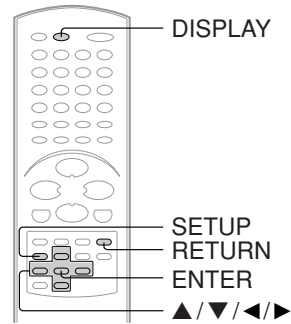

DVD Setting on screen display

On screen display can be switched on or off when you press the buttons.

1 Press **SETUP** in the stop mode or No Disc. Press **◀** or **▶** to select "Picture".

Language **Picture** Sound Parental Other
 ◀▶▲▼/Enter/Setup/Return

2 Press **▼** or **ENTER**, then press **▲** or **▼** to select "Display".

Language **Picture** Sound Parental Other
 E.B.L. Off
 Tv Screen 4:3
 Display **On**
 JPEG Interval Off
 Select Files All
 ▶▶▲▼/Enter/Setup/Return

3 Press **◀/▶** or **ENTER** to select "On" or "Off".

Language **Picture** Sound Parental Other
 E.B.L. Off
 Tv Screen 4:3
 Display **Off**
 JPEG Interval Off
 Select Files All
 ▶▶▲▼/Enter/Setup/Return

On: On screen displays appear when you press the buttons (factory setting).
Off: On screen displays do not appear when you press any buttons.

4 To make **SETUP** screen disappear, press **SETUP** or **RETURN** while the **SETUP** screen is being displayed.

DVD/VCD/CD Status display of disc

Each press of **DISPLAY**, the status display of the disc will appear on the screen and change as follows.

DVD

00:34:56 01:12:33

➔

▶ 00:34:56 01:12:33
 Title 1/99 Chapter 1/999 1/9
 1/8 Eng DolbyDigital
 1/32 Eng

To make status display disappear, press **DISPLAY** again.

Video CD

00:12 04:32

➔

▶PBC 00:12 04:32
 Track -/-

Audio CD

▶ 34:56 71:33
 Track 11/99

When you playback the CD disc, the status display will appear on the screen and continue displaying.

Function setup (DVD)





Dynamic Range Control

DRC (Dynamic Range Control) enables you to control the dynamic range so as to achieve a suitable sound for your equipment.

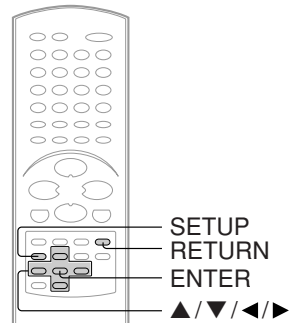

DVD Dynamic Range Control

1 Press **SETUP** in the stop mode.
Press **◀** or **▶** to select "Sound".

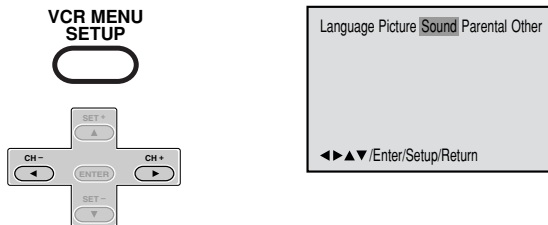

4 To make **SETUP** screen disappear, press **SETUP** or **RETURN** while the **SETUP** screen is being displayed.

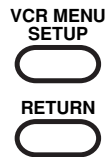

2 Press **▼** or **ENTER** to select "Dialogue".

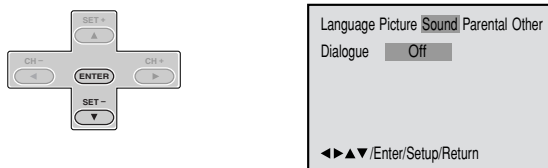

Notes:

- This function works only during playback of Dolby Digital recorded discs.
- The level of Dynamic Range Reduction may differ depending on DVD video disc.

3 Press **▶** or **ENTER**, then press **▲** or **▼** to select desired setting.

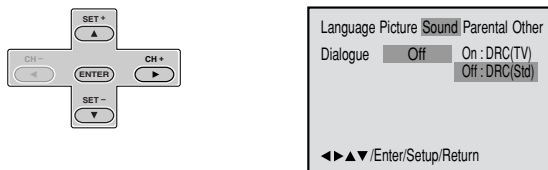

- On:** Loud sound such as explosion or the like is toned down slightly when played back. This makes it suitable for when it is connected to a stereo.
- Off:** It plays back at the recording level on the disc.





Parental control setting

Some discs are specified not suitable for children. Such discs can be limited not to play back with the unit.

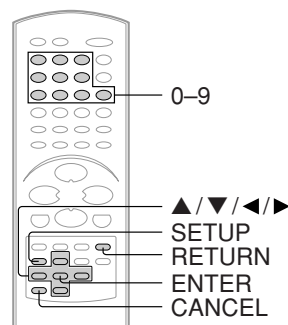

DVD Parental control setting

1 Press **SETUP** in the stop mode or No Disc. Press **◀** or **▶** to select "Parental". Then press **▼** or **ENTER**.

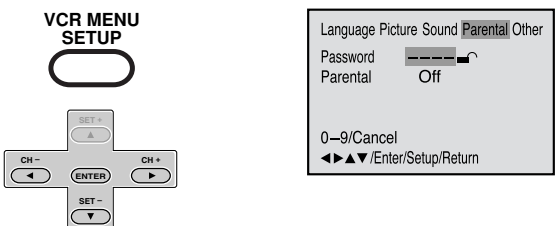

VCR MENU SETUP

Language Picture Sound **Parental** Other

Password

Parental Off

0-9/Cancel
◀▶▲▼/Enter/Setup/Return

4 Press **ENTER** to store the password.

Note: Now the rating is locked and the setting cannot be changed unless you enter the correct password.

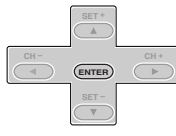
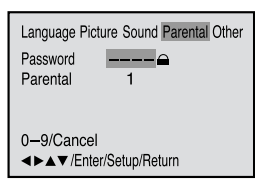
Language Picture Sound **Parental** Other

Password

Parental 1

0-9/Cancel
◀▶▲▼/Enter/Setup/Return

2 Press **▲** or **▼** to select "Parental", then press **◀** or **▶** until the level you require appears.

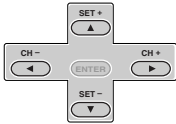
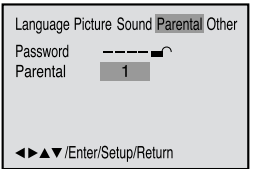
Language Picture Sound **Parental** Other

Password

Parental 1

◀▶▲▼/Enter/Setup/Return

5 Press **SETUP** or **RETURN** to remove the parental control screen.



VCR MENU SETUP

RETURN

- **Level Off:** The parental control setting does not function.
- **Level 8:** All DVD software can be played back.
- **Level 1:** DVD software for adults cannot be played back.
- Select from the level 1 to level 8. The limitation will be more severe as the level number is lower.

- Notes:**
- If each setup (pages 57-66) has been completed, the unit can always be worked under the same conditions (especially with DVD discs). Each setup will be retained in the memory if you turn the power off.
 - Depending on the discs, the unit cannot limit playback.
 - Some discs may not be encoded with specific rating level information though its disc jacket says "adult." For those discs, the age restriction will not work.

3 Press **▲** or **▼** to select "Password". Press Number buttons (0-9) to input a 4-digit password.

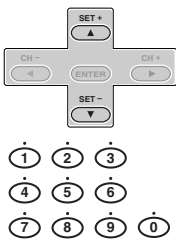
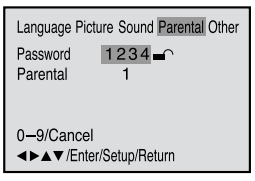
Language Picture Sound **Parental** Other

Password

Parental 1

0-9/Cancel
◀▶▲▼/Enter/Setup/Return

Be sure to remember this number!

- If you input a wrong number, press **CANCEL**.

Function setup (DVD)



To change the parental level

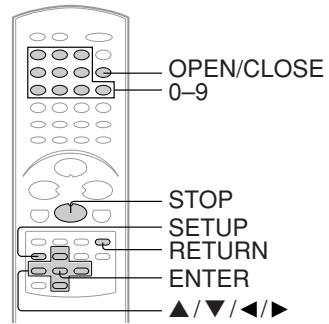

DVD To change the parental level

1 Press **SETUP** in the stop mode or No Disc. Press **◀** or **▶** to select "Parental". Then press **▼** or **ENTER**.

VCR MENU SETUP

Language Picture Sound **Parental** Other
 Password **----**
 Parental 1

0-9/Cancel
 ◀▶▲▼/Enter/Setup/Return

2 Press Number buttons (0-9) to enter the password you have stored.

Language Picture Sound **Parental** Other
 Password **1234**
 Parental 1

0-9/Cancel
 ◀▶▲▼/Enter/Setup/Return

3 Press **ENTER**.
 The rating is now unlocked.

Language Picture Sound **Parental** Other
 Password **----**
 Parental 1

0-9/Cancel
 ◀▶▲▼/Enter/Setup/Return

4 Press **▲** or **▼** to select "Parental", then press **◀** or **▶** to change the parental level.

Language Picture Sound **Parental** Other
 Password **----**
 Parental **5**

◀▶▲▼/Enter/Setup/Return

5 Press **▲** or **▼** to select "Password", then press Number buttons (0-9) to enter the password.

Note: You can change the password if you want.

Language Picture Sound **Parental** Other
 Password **9876**
 Parental 5

0-9/Cancel
 ◀▶▲▼/Enter/Setup/Return

6 Press **ENTER**.
 Now the parental level is changed and locked.

Language Picture Sound **Parental** Other
 Password **----**
 Parental 5

0-9/Cancel
 ◀▶▲▼/Enter/Setup/Return

7 Press **SETUP** or **RETURN** to remove the parental control screen.

VCR MENU SETUP

RETURN

- If you forget the password...**
1. Press **OPEN/CLOSE** to open the disc tray.
 2. Remove the disc.
 3. Press **OPEN/CLOSE** again to close the disc tray. "No Disc" appears on the screen.
 4. While holding **7** down on the remote control, press **STOP** on the front panel. "PASSWORD CLEAR" appears on the screen.
 5. Enter a new password again.



Temporary disabling of rating level by DVD disc

Depending on the DVD disc, the disc may try to temporarily cancel the rating level that you have set. It is up to you to decide whether to cancel the rating level or not.

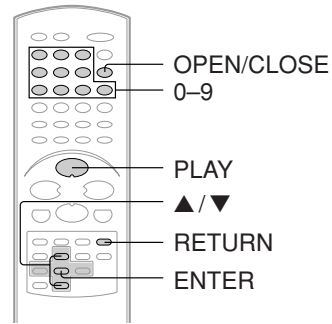

DVD Temporary disabling of rating level by DVD disc

- 1** Load a DVD disc and press PLAY or OPEN/CLOSE on the unit [42](#).

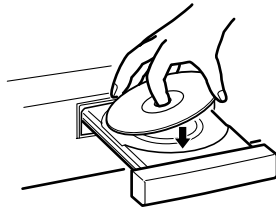
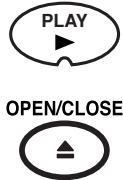

- 2** If the DVD disc has been designed to temporarily cancel the Rating level, the screen which follows the "Reading" screen will change, depending on which disc is played. If you select "YES" with the ENTER key, "Your disc exceeds the parental control level#." screen will then appear.



Your disc exceeds the parental control level#.

Parental Control Level
Cancel Picture
▲▼/Enter/Return

- 3** If you wish to cancel the set rating level temporarily, select "Parental Control Level" with ▲ or ▼, then press ENTER. If the 4-digit password at step 2 on page 62 has been set, the password entering screen will appear as shown in step 4. Alternatively, if the password has not been set, playback will commence. If you don't know (or have forgotten) the password, select "Cancel Picture". The setting screen will disappear. Press OPEN/CLOSE to remove the disc.

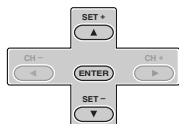

- 4** Enter the password with Number buttons (0-9). Then press ENTER.

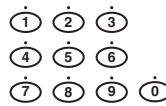

If you interrupt the entering, press RETURN.

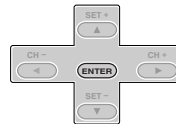

Please enter the 4 - digit password
[] [] [] []
Enter/0 - 9/Cancel/Return

- 5** Playback will commence if the entered password was correct.

Note:

This temporary cancellation of rating level will be kept until the disc is ejected. When the disc is ejected, the original rating level will be set again automatically.

Setting OSD language

The setup language can be selected.

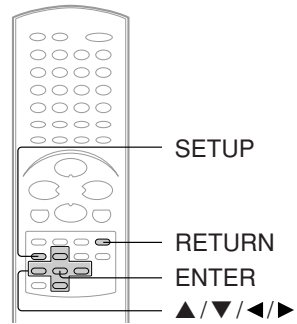

DVD VCD CD Setting OSD language

1 Press **SETUP** in the stop mode or **NO DISC**. Press **◀** or **▶** to select "Other".

VCR MENU
SETUP

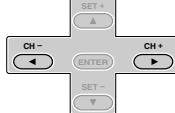



Language Picture Sound Parental **Other**

◀▶▲▼/Enter/Setup/Return

4 To make **SETUP** screen disappear, press **SETUP** or **RETURN** while the **SETUP** screen is being displayed.

VCR MENU
SETUP



RETURN



2 Press **▼** or **ENTER** to select "OSD Language".

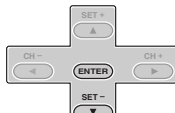

Language Picture Sound Parental **Other**

OSD Language **English**

◀▶▲▼/Enter/Setup/Return

If the unit does not operate properly: Static electricity, etc., may affect the player's operation. Disconnect the AC power cord once, then connect it again.

3 Press **▶** or **ENTER** and then press **▲** or **▼** to select desired language (e.g. English), then press **ENTER**.

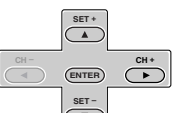

Language Picture Sound Parental **Other**

OSD Language **English** English
Français
Español

◀▶▲▼/Enter/Setup/Return



Setting language

You can select the language of "Menu", "Subtitle" and "Audio" if their languages are recorded onto the disc more than one language.

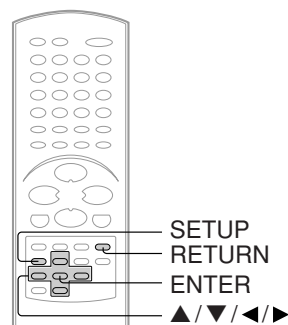

DVD Setting language

1 Press **SETUP** in the stop mode or No Disc. Press **◀** or **▶** to select "Language".

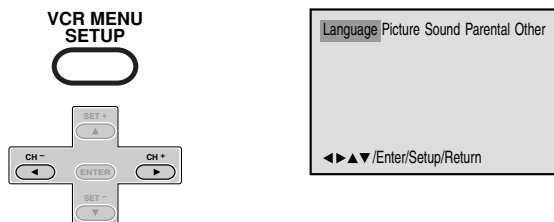

4 To make **SETUP** screen disappear, press **SETUP** or **RETURN** while the **SETUP** screen is being displayed.



2 Press **▼** or **ENTER**, then press **▲** or **▼** to select desired language item.

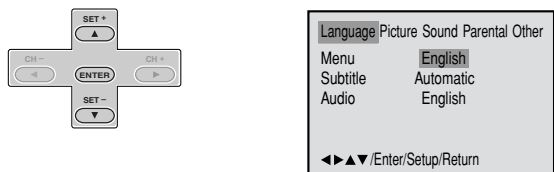

Note:

If the selected language is not recorded on the disc, the first-priority language is selected.

3 Press **▶** or **ENTER**. Press **▲** or **▼** to select your desired language, then press **ENTER**.

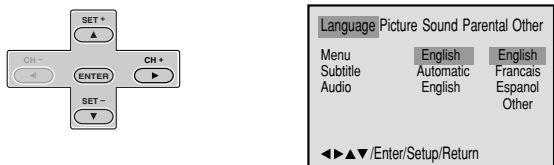

English, Francais, Espanol:

The selected language will be heard or seen.

Other:

Other language can be selected (see "Language code list" on page 67).

Original: (Audio)

The unit will select the first priority language of each disc.

Automatic: (Subtitle)

- The unit will automatically select the same language in the AUDIO setting.
- When the unit selects the same language as the AUDIO, the subtitles will not appear during playback.
- When you do not use the same language as the AUDIO, the subtitles will appear during playback.

Off: (Subtitle)

Subtitles do not appear.

Function setup (DVD)



Selecting *PROGRESSIVE* scan

The progressive scan capability provides the highest resolution pictures with less flicker and line structure.

If you are using the Component video jacks, but are connecting the DVD/VCR to a standard (analog) television, set **PROGRESSIVE** to Off.

If you are using the Component video jacks for connection to a TV or monitor that is compatible with a progressive scan signal, set **PROGRESSIVE** to On.

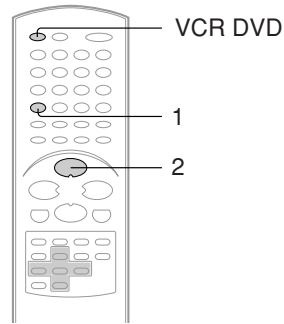

Selecting PROGRESSIVE scan

Preparation:

- Connect to a TV equipped with component jacks.
- Turn ON the TV and set it to the corresponding video input mode.
- Set the S-VIDEO/COMPONENT video selector switch on the rear panel to COMPONENT position.
- Press **VCR DVD** selector to select the DVD mode. (The DVD indicator will light.)

1 Press **PROGRESSIVE** in the stop mode.

INPUT SELECT
PROGRESSIVE



The progressive indicator "P" on the display window will light.

- The unit recognizes the picture source (film or video) of the current disc according to the disc information.

2 Press **PLAY** to start playback.



There are two types of source content in pictures recorded in DVD video discs: film content (pictures recorded from films at 24 frames per second) and video content (video signals recorded at 30 frames per second).

When the unit plays back a film source material, uninterlaced progressive output signals are created using the original information. When a video content is played back, the unit interleaves lines between the interlaced lines on each to create the interpolated picture and outputs as the progressive signal.

■ To select **PROGRESSIVE** scan Off

Press **PROGRESSIVE** in the stop mode.

The progressive indicator "P" on the display window will go off.

Notes:

- Some discs may not be played back with the progressive scanning mode correctly because of the disc characteristics or recording condition.
- If your TV does not accept the progressive scan format, the picture will appear scrambled if you select progressive scan output from the unit. In such a case, select **PROGRESSIVE** scan Off.
- Once **PROGRESSIVE** scan On, all other video outputs are disabled except component video outputs.
- You cannot make the progressive scanning mode active in following cases.
 - The unit is in the VCR mode.
 - The disc is played back in the DVD mode.
 - The S-VIDEO/COMPONENT video selector switch is set to S-VIDEO position.



Language code list

Enter the appropriate code number for the initial settings "Menu", "Subtitle" and/or "Audio" **65**.

Language Name	Code	Language Name	Code	Language Name	Code	Language Name	Code
Abkhazian	1112	Fiji	1620	Lingala	2224	Singhalese	2919
Afar	1111	Finnish	1619	Lithuanian	2230	Slovak	2921
Afrikaans	1116	French	1628	Macedonian	2321	Slovenian	2922
Albanian	2927	Frisian	1635	Malagasy	2317	Somali	2925
Amharic	1123	Galician	1722	Malay	2329	Spanish	1529
Arabic	1128	Georgian	2111	Malayalam	2322	Sundanese	2931
Armenian	1835	German	1415	Maltese	2330	Swahili	2933
Assamese	1129	Greek	1522	Maori	2319	Swedish	2932
Aymara	1135	Greenlandic	2122	Marathi	2328	Tagalog	3022
Azerbaijani	1136	Guarani	1724	Moldavian	2325	Tajik	3017
Bashkir	1211	Gujarati	1731	Mongolian	2324	Tamil	3011
Basque	1531	Hausa	1811	Nauru	2411	Tatar	3030
Bengali; Bangla	1224	Hebrew	1933	Nepali	2415	Telugu	3015
Bhutani	1436	Hindi	1819	Norwegian	2425	Thai	3018
Bihari	1218	Hungarian	1831	Oriya	2528	Tibetan	1225
Breton	1228	Icelandic	1929	Panjabi	2611	Tigrinya	3019
Bulgarian	1217	Indonesian	1924	Pashto, Pushto	2629	Tonga	3025
Burmese	2335	Interlingua	1911	Persian	1611	Turkish	3028
Byelorussian	1215	Irish	1711	Polish	2622	Turkmen	3021
Cambodian	2123	Italian	1930	Portuguese	2630	Twi	3033
Catalan	1311	Japanese	2011	Quechua	2731	Ukrainian	3121
Chinese	3618	Javanese	2033	Rhaeto-Romance	2823	Urdu	3128
Corsican	1325	Kannada	2124	Romanian	2825	Uzbek	3136
Croatian	1828	Kashmiri	2129	Russian	2831	Vietnamese	3219
Czech	1329	Kazakh	2121	Samoan	2923	Volapük	3225
Danish	1411	Kirghiz	2135	Sanskrit	2911	Welsh	1335
Dutch	2422	Korean	2125	Scots Gaelic	1714	Wolof	3325
English	1524	Kurdish	2131	Serbian	2928	Xhosa	3418
Esperanto	1525	Laothian	2225	Serbo-Croatian	2918	Yiddish	2019
Estonian	1530	Latin	2211	Shona	2924	Yoruba	3525
Faroese	1625	Latvian, Lettish	2232	Sindhi	2914	Zulu	3631

Troubleshooting

Check the following guide for the possible cause of a problem before contacting service.

SYMPTOMS	POSSIBLE SOLUTIONS	PAGE
DVD/VCR		
DVD/VCR does not operate.	<ul style="list-style-type: none"> • Make sure the power cord is plugged in. • Try another AC outlet. • Power is off, check fuse or circuit breaker. • Unplug unit, then plug it back in. • Select the DVD or VCR mode before operating. 	5 – – 5 30,42
No picture.	<ul style="list-style-type: none"> • Antenna connection is not correct or antenna cable is disconnected. • The video channel is not in the correct position or the TV is not set to the video channel 3 or 4. • Check the unit is connected correctly. • The video input selector of the TV is not set to VIDEO. Set to VIDEO (or equivalent). • Channel is set to the external mode. 	14~17 22 14~19 – –
No sound.	<ul style="list-style-type: none"> • Check the unit is connected correctly. • Check the input selector of the amplifier is set properly. • The unit is in the Special playback mode. 	14~19 – 31,44
The remote control does not function.	<ul style="list-style-type: none"> • Aim the remote control at the remote sensor. • Operate within Approx. 7 Meters or reduce the light in the room. • Clear the path of the beam. • The batteries are weak. Replace the batteries. • Check the batteries are inserted correctly. 	13
No CATV reception.	<ul style="list-style-type: none"> • Check all CATV connections. • Station or CATV system problems, try another station. 	16,17
VCR		
TV recording does not work.	<ul style="list-style-type: none"> • The erase prevention tab of the video cassette is broken off. • The unit is in the external input mode. 	29,34
Timer recording does not work.	<ul style="list-style-type: none"> • The time is not set correctly. • The recording start/end time is not set correctly. • The TIMER REC has not been pressed (⏻ is not lit). 	24 37 37
Noise bars on screen.	<ul style="list-style-type: none"> • Tracking adjustment beyond range of automatic tracking circuit. Try Manual tracking adjustment. • Video heads are dirty. • The tape is worn or damaged. 	31 31 –
DVD		
Display is not shown in your language.	<ul style="list-style-type: none"> • Select proper language in the menu options. 	64
Playback doesn't start.	<ul style="list-style-type: none"> • No disc is inserted. • The disc may be dirty. Clean up the disc. • The unit cannot play DVD-ROMs, etc. 	42 6 8
Stopping playback, slow-motion play, repeat play, or memory play, etc. cannot be performed.	<ul style="list-style-type: none"> • Some discs may not do some of the functions. 	–
No picture, or the screen is blurred or divided into two parts.	<ul style="list-style-type: none"> • The S-VIDEO/COMPONENT selector is not set correctly. • The PROGRESSIVE scan is On through the unit is connected to a TV via the VIDEO OUT or the S-VIDEO OUT jack. 	19 66
No 4:3 (16:9) picture.	<ul style="list-style-type: none"> • The setup does not match your TV. 	58
No on-screen display.	<ul style="list-style-type: none"> • Select Display "On". 	59
No surround sound.	<ul style="list-style-type: none"> • The setup does not match your stereo system. 	20
The unit or remote operation key is not functioning.	<ul style="list-style-type: none"> • Turn off the unit and unplug the AC power cord for several minutes, then replug it. 	–
Playback does not start when the title is selected.	<ul style="list-style-type: none"> • Check the Parental setup. 	61,62
Audio soundtrack and/or subtitle language is not changed when you play back a DVD.	<ul style="list-style-type: none"> • Multilingual language is not recorded on the DVD disc. 	65
No subtitle.	<ul style="list-style-type: none"> • Some discs have no subtitles. • Subtitles are cleared. Press SUBTITLE. 	56
Angle cannot be changed.	<ul style="list-style-type: none"> • Multi-angles are not recorded on the DVD disc. 	54
⏻ appears on the screen.	<ul style="list-style-type: none"> • The function is prohibited with the unit or the disc. 	44



Specifications

General

Power supply	AC 120 V 60 Hz
Power consumption	Operation: 18 W, Stand by: 2 W
Weight	7.9 lbs (3.6 kg)
Dimensions	Width: 16-15/16 inches (430 mm) Height: 3-7/8 inches (99 mm) Depth: 9-13/16 inches (250.5 mm)
Tuner	181 channel freq. synthesized VHF 2-13 UHF 14-69 CATV 125 Channels
Antenna input/output	UHF/VHF In/Out: 75 Ω coaxial
RF channel output	Channel 3 or 4, Switchable
Color system	NTSC
Video head	4 Rotary heads
Audio track	Hi-Fi sound - 2 Tracks / MONO sound - 1 Track
Hi-Fi frequency response	20 Hz to 20,000 Hz
Hi-Fi dynamic range	More than 90dB
F.FWD/REW time at 25°C (77°F)	Approx. 1 minute and 48 seconds (with T-120 Cassette Tape)
Applicable disc	DVD (12 cm, 8 cm), CD (12 cm, 8 cm)
Frequency range	DVD: 4 Hz-22 kHz, CD: 4 Hz-20 kHz
S/N ratio	90dB (DVD)
Harmonic distortion	0.02% (DVD)
Wow and flutter	Less than 0.01% Wrms
Operating conditions	Temperature: 5°C-40°C (41°F-104°F), Operating status: Horizontal

Input/Output

DVD/VCR	
Video input	1.0 V (p-p), 75 Ω, negative sync., pin jack x 2
Video output	1.0 V (p-p), 75 Ω, negative sync., pin jack x 1
Audio input	-8 dBm, 50 kΩ, negative sync., pin jack (L/R) x 2
Audio output	-8 dBm, 1 kΩ, negative sync., pin jack (L/R) x 1
DVD	
S-video output	(Y) 1.0 V (p-p), 75 Ω, negative sync., Mini DIN 4-pin x 1 (C) 0.286 V (p-p), 75 Ω
Component video output	(Y) 1.0 V (p-p), 75 Ω, negative sync., pin jack x 1 (P _B)/(P _R) 0.7 V (p-p), 75 Ω, pin jack x 2
Audio output (BITSTREAM/PCM COAXIAL)	0.5 V (p-p), 75 Ω, pin jack x 1
Audio output (BITSTREAM/PCM OPTICAL)	Optical connector x 1
Audio output (ANALOG)	-12 dB, 1 kΩ, pin jacks (L, R) x 1
S-VIDEO/COMPONENT video selector	Slide switch x 1

Supplied accessories

Audio/video cable	1
Remote control (SE-R0108)	1
Batteries (R03/AAA)	2
75 ohm coaxial cable	1

• Designs and specifications are subject to change without notice.

Others



Limited warranty

Limited United States Warranty DVD Players - Exchange Warranty

Toshiba America Consumer Products, L.L.C. ("TACP") makes the following limited warranties to original consumers in the United States. THESE LIMITED WARRANTIES EXTEND TO THE ORIGINAL CONSUMER PURCHASER OR ANY PERSON RECEIVING THIS DVD PLAYER AS A GIFT FROM THE ORIGINAL CONSUMER PURCHASER AND TO NO OTHER PURCHASER OR TRANSFEREE

PRODUCTS PURCHASED IN THE U.S.A. AND USED IN CANADA ARE NOT COVERED BY THESE WARRANTIES

PRODUCTS PURCHASED IN CANADA AND USED IN THE U.S.A. ARE NOT COVERED BY THESE WARRANTIES.

Limited Ninety (90) Day Warranty

TACP warrant this DVD PLAYER and its parts against defects in materials or workmanship for a period of ninety (90) days after the date of original retail purchase. DURING THE FIRST 90 DAYS FROM THE PURCHASE DATE, TACP WILL EXCHANGE A DEFECTIVE DVD PLAYER WITH A NEW OR REFURBISHED PLAYER WITHOUT CHARGE TO YOU. YOU MUST CONTACT TOSHIBA'S CONSUMER SOLUTIONS CENTER FOR INSTRUCTIONS ON HOW TO PROCESS YOUR IN WARRANTY EXCHANGE REQUEST. THE CONSUMER IS RESPONSIBLE FOR ALL INBOUND TRANSPORTATION AND INSURANCE CHARGES FOR THE DVD PLAYER TO THE EXCHANGE CENTER. DURING THE PERIOD FROM 91 DAYS AND BEYOND, FROM THE PURCHASE DATE, TACP WILL EXCHANGE A DEFECTIVE DVD PLAYER WITH A NEW OR REFURBISHED PLAYER FOR A NOMINAL FEE. YOU MUST CONTACT TOSHIBA'S CONSUMER SOLUTIONS CENTER FOR INSTRUCTIONS ON HOW TO PROCESS YOUR EXCHANGE REQUEST. THE CONSUMER IS RESPONSIBLE FOR ALL INBOUND TRANSPORTATION AND INSURANCE CHARGES FOR THE DVD PLAYER TO THE EXCHANGE CENTER.

*Rental Units

The warranty for rental units begins with the first rental or thirty (30) days from the date of shipment to the rental firm, whichever comes first.

*Commercial Units

DVD PLAYERS sold and used for commercial purposes have a limited ninety (90) day warranty for all parts, labor.

Owner's Manual and Demographic Card

You should read this owner's manual thoroughly before operating this DVD PLAYER. You should complete and mail the enclosed Demographic card within ten days after you, or the person who has given you this product as a gift, purchased this DVD PLAYER. This is one way to enable TACP to provide you with better customer service and improved products. Failure to return the Demographic card will not affect your rights under this warranty.

Your Responsibility

THE ABOVE WARRANTIES ARE SUBJECT TO THE FOLLOWING CONDITIONS:

- (1) You must provide your bill of sale or other proof of purchase.
- (2) All warranty servicing of this DVD PLAYER must be made by an Authorized TACP Service Station.
- (3) The warranties from TACP are effective only if the DVD PLAYER is purchased and operated in the U.S.A. or Puerto Rico.
- (4) Labor service charges for set installation, set up, adjustment of customer controls and installation or repair of antenna systems are not covered by these warranties. Reception problems caused by inadequate antenna systems are your responsibility.
- (5) Warranties extend only to defects in materials or workmanship as limited above and do not extend to any DVD PLAYER or parts which have been lost or discarded by you or to damage to DVD PLAYER or parts caused by misuse, accident, Acts of God, such as lightning or fluctuations in electric power, improper installation, improper maintenance or use in violation of instructions furnished by TACP; or to units which have been modified or had the serial number removed, altered, defaced or rendered illegible.



How to Obtain Warranty Services

If, after following all of the operating instructions in this manual and checking the section "Troubleshooting", you find that service is needed:

- (1) For instructions on how to obtain warranty service for exchange program DVD Players, contact TACP'S toll free Call Center at 1-866-583-7353.
- (2) Include your bill of sale or other proof of purchase along with the DVD player, when sending it to the Authorized TACP Service Station SPECIFIED by TACPs Call Center. You must pay for all transportation and insurance charges for the DVD Product to and from the Service Station.

For additional information, visit TACP's web site:
www.tacp.toshiba.com

ALL WARRANTIES IMPLIED BY THE LAW OF ANY STATE OF THE U.S.A., INCLUDING THE IMPLIED WARRANTIES OF MERCHANTABILITY AND FITNESS FOR A PARTICULAR PURPOSE, ARE EXPRESSLY LIMITED TO THE DURATION OF THE LIMITED WARRANTIES SET FORTH ABOVE. WITH THE EXCEPTION OF ANY WARRANTIES IMPLIED BY THE LAW OF ANY STATE OF THE U.S.A. AS HEREBY LIMITED, THE FOREGOING WARRANTY IS EXCLUSIVE AND IN LIEU OF ALL OTHER WARRANTIES, GUARANTEES, AGREEMENTS AND SIMILAR OBLIGATIONS OF TACP OR THI WITH RESPECT TO THE REPAIR OR REPLACEMENT OF ANY PARTS. IN NO EVENT SHALL TACP BE LIABLE FOR CONSEQUENTIAL OR INCIDENTAL DAMAGES.

No person, agent, distributor, dealer or company is authorized to change, modify or extend the terms of these warranties in any manner whatsoever. The time within which action must be commenced to enforce any obligation of TACP arising under this warranty or under any law of the United States or of any state thereof is hereby limited to 90 days from the date you discovered or should have discovered, the defect. This limitation does not apply to implied warranties arising under the law of any state of the U.S.A.

THIS WARRANTY GIVES YOU SPECIFIC LEGAL RIGHTS, AND YOU MAY ALSO HAVE OTHER RIGHTS WHICH MAY VARY FROM STATE TO STATE IN THE U.S.A. SOME STATES OF THE U.S.A. DO NOT ALLOW LIMITATIONS ON HOW LONG AN IMPLIED WARRANTY LASTS, WHEN AN ACTION MAY BE BROUGHT, OR THE EXCLUSION OR LIMITATION OF INCIDENTAL OR CONSEQUENTIAL DAMAGES, SO THE AFOREMENTIONED LIMITATIONS OR EXCLUSIONS MAY NOT APPLY TO YOU UNDER SUCH CIRCUMSTANCES.

Others



TOSHIBA



J2C53601A

04/04 U

Printed in Thailand





TOSHIBA

REPRODUCTOR DE DVD & VIDEOGRABADOR DE CASSETTE SD-V396SU

Referencia rápida



PRECAUCION

RIESGO DE DESCARGA
ELECTRICA NO ABRIR



AVISO: PARA REDUCIR EL RIESGO DE DESCARGA ELECTRICA, NO RETIRE LA CUBIERTA (O POSTERIOR). EN EL INTERIOR DEL APARATO NO HAY COMPONENTE ALGUNO QUE PRECISE SERVICIO DE MANTENIMIENTO A CARGO DEL USUARIO. SOLICITE CUALQUIER OPERACION DE MANTENIMIENTO A PERSONAL DE SERVICIO CALIFICADO.



El símbolo del rayo dentro de un triángulo equilátero tiene por finalidad alertar al usuario acerca de la presencia de tensión peligrosa (sin aislación) en el interior del producto, que puede tener la intensidad suficiente como para constituir un riesgo de descarga eléctrica.



El signo de exclamación dentro de un triángulo equilátero tiene por finalidad alertar al usuario de importantes instrucciones de operación y mantenimiento (servicio) en la literatura que acompaña a este aparato.

AVISO: Para reducir el riesgo de incendio o descarga eléctrica, no exponga esta unidad a la lluvia ni a la humedad.

ADVERTENCIA: Este equipo ha sido sometido a pruebas y cumple con los límites establecidos para un aparato digital de Clase B, de acuerdo con la Parte 15 del Reglamento de la FCC. Estos límites están diseñados para proporcionar protección razonable contra interferencias perjudiciales en una instalación residencial. Este equipo genera o emplea energía de radiofrecuencia y, si no es instalado y empleado de acuerdo con estas instrucciones, puede causar interferencias perjudiciales a las radiocomunicaciones. Sin embargo, no garantizamos que no ocurrirán interferencias en una instalación en particular. Si este equipo causa interferencias perjudiciales a la recepción radial o televisiva, situación que puede ser determinada apagando y encendiendo el equipo, se sugiere al usuario que trate de corregir tal interferencia mediante una o más de las siguientes medidas:

- Reorientar o relocalizar la antena receptora.
- Incrementar la separación entre el equipo y el receptor.
- Conectar el equipo a un tomacorriente o circuito diferente al que está conectado al receptor.
- Consultar con el concesionario o un técnico experimentado solicitándole su asistencia.

PRECAUCION: El usuario corre el riesgo de perder la autorización para hacer funcionar este equipo en caso de que ejecute un cambio o modificación no aprobado por la parte responsable para la conformidad con las Reglas FCC.

PRECAUCION:

ESTE TOCADISCOS DE VIDEO DIGITAL UTILIZA UN SISTEMA LASER.

PARA UTILIZAR CORRECTAMENTE ESTE PRODUCTO, LEA CUIDADOSAMENTE ESTE MANUAL DE INSTRUCCIONES Y GUARDELO PARA SU REFERENCIA EN EL FUTURO. SI FUERA NECESARIO HACER UN MANTENIMIENTO DE ESTE APARATO, CONSULTE CON UN CENTRO DE SERVICIO AUTORIZADO-LEA EL PROCEDIMIENTO DE SERVICIO.

EL USO DE LOS CONTROLES, AJUSTES O LA REALIZACION DE OTROS PROCEDIMIENTOS QUE NO SEAN LOS ESPECIFICADOS AQUI PUEDE PROVOCAR UNA EXPOSICION A RADIACIONES PELIGROSAS.

PARA EVITAR LA EXPOSICION DIRECTA A LOS RAYOS LASER, NO TRATE DE ABRIR LA CAJA. PUEDE HABER UNA RADIACION LASER VISIBLE AL ABRIR LA CAJA. NO MIRE HACIA EL RAYO.

©2004 Toshiba Corporation

Este dispositivo no graba en cinta DVDs protegidos contra copias.



INSTRUCCIONES IMPORTANTES

- 1. LEA LAS INSTRUCCIONES**

Antes de usar la unidad, lea detenidamente todas las instrucciones de seguridad y operación.
 - 2. CONSERVE ESTE MANUAL DE INSTRUCCIONES**

Conserve las instrucciones de seguridad y operación para consultas futuras.
 - 3. RESPETE LAS ADVERTENCIAS**

Observe estrictamente todas las advertencias impresas en la unidad y las incluidas en el manual de instrucciones.
 - 4. SIGA LAS INSTRUCCIONES**

Siga todas las instrucciones de operación y uso.
 - 5. LIMPIEZA**

Antes de limpiar este videograbador, desconéctelo del tomacorriente mural. No use limpiadores líquidos ni aerosol. Utilice sólo un paño húmedo para limpiar el exterior del mueble.
 - 6. ENCHUFES**

El fabricante de esta unidad no hace ninguna recomendación de accesorios ya que pueden ser peligrosos.
 - 7. AGUA Y HUMEDAD**

No utilice este aparato cerca del agua. Por ejemplo cerca de una bañera, lavabo, pileta de la cocina, lavadero, en un sótano húmedo o cerca de una piscina.
 - 8. ACCESORIOS**

No instale esta unidad en un carro, soporte, trípode o mesa inestables. La unidad podría caerse, causando serias lesiones, resultando también severamente dañada a la unidad.
 - 8A. La combinación de aparato y carro deberá ser movida con cuidado. Las detenciones bruscas, la fuerza excesiva y las superficies dispares harán hacer que el aparato y el carro se vuelven.**
 - 9. VENTILACION**

Las ranuras y aberturas en la parte trasera o inferior del mueble son para ventilación permiten un funcionamiento fiable de la unidad, protegiendo contra calentamiento excesivo. Estas aberturas no deberán ser bloqueadas ni cubiertas. Para evitar bloquear las aberturas, nunca sitúe la unidad encima de una cama, sofá, alfombra u otra superficie similar. Tampoco instale la unidad cerca o encima de un radiador o calefactor. La unidad no deberá ser instalado en un mueble empotrado, como ser una repisa para libros o bastidor, a menos que se pueda garantizar una ventilación adecuada, y/o cuando las instrucciones del fabricante así lo especifiquen.
 - 10. FUENTES DE ALIMENTACION**

Esta unidad sólo deberá ser operada mediante el tipo de fuente de alimentación especificado en la etiqueta indicadora. Si no está seguro del tipo de fuente de alimentación que tiene en su casa, consulte a su distribuidor o a la compañía de electricidad local. En el caso de unidades diseñadas para funcionar a pilas o con otras fuentes de alimentación, consulte el manual de instrucciones respectivo.
 - 11. CONEXIÓN A TIERRA O POLARIZACION**

Esta unidad está equipada con una clavija polarizada de corriente alterna (una clavija que tiene una espiga más ancha que la otra). Esta clavija solamente puede ser insertada en el tomacorriente en una sola dirección. Esta es una medida de seguridad. Si no pudiera insertar completamente la clavija en el tomacorriente, vuelva a intentarlo invirtiendo la clavija. Si aún no fuera posible insertar la clavija, tome contacto con un electricista para que reemplace su tomacorriente obsoleto. En lugar de la clavija polarizada de corriente alterna, su unidad puede estar equipada con una clavija de conexión a tierra de 3 alambres (una clavija con una tercera espiga de conexión a tierra). Este tipo de clavija sólo puede ser insertado en un tomacorriente con contacto a tierra. Esto también es una medida de seguridad. Si no pudiera insertar la clavija en el tomacorriente, tome contacto con un electricista para que reemplace su tomacorriente obsoleto. No modifique las características de seguridad de la clavija de conexión a tierra.
 - 12. PROTECCION DEL CABLE DE ALIMENTACION**

Los cables de alimentación deberán ser tendidos de manera tal que la probabilidad de que sean pisados o aplastados por otros objetos sea mínima. Preste especial atención a las clavijas de los cables, a los receptáculos, y al punto por donde salen del aparato.
 - 13. TORMENTAS ELECTRICAS**

Como medida de protección durante tormentas eléctricas, o cuando el videograbador permanezca sin uso durante períodos prolongados de tiempo, desconéctelo del tomacorriente mural y desconecte la antena o el sistema de cable. Esto evitará que la unidad resulte dañada por tormentas eléctricas o sobretensiones en la línea de alimentación.
 - 14. LINEAS DE ALIMENTACION**

Un sistema de antena exterior no debería situarse cerca de líneas de alimentación aéreas ni de otros circuitos de luz eléctrica o potencia, o donde pueda caerse o entrar en contacto con tales líneas o circuitos de alimentación. Al instalar un sistema de antena exterior, tenga mucho cuidado de no tocar tales líneas o circuitos de alimentación, ya que el contacto con ellos podría ser fatal.
 - 15. SOBRECARGA**

No sobrecargue los tomacorrientes murales ni los cables de extensión, ya que esto podría causar incendios o descargas eléctricas.
 - 16. ENTRADA DE OBJETOS Y LIQUIDOS**

Nunca introduzca objetos de ningún tipo por las aberturas de la unidad, ya que podría tocar peligrosos puntos de alta tensión o piezas de cortocircuito, provocando incendios o descargas eléctricas. Nunca derrame ni rocíe ningún tipo de líquido sobre la unidad.
 - 17. CONEXION A TIERRA DE LA ANTENA EXTERIOR**

Si se conecta una antena externa o sistema de cable a la unidad, cerciórese de que el sistema de antena o cable está conectado a tierra para darle protección contra sobretensión y acumulación de carga estática. La Sección 810 del Código Nacional de Electricidad, ANSI/NFPA 70, entrega información acerca de la manera correcta de conectar a tierra el mástil y la estructura soportante, puesta a tierra del alambre de entrada a una unidad de descarga de antena, tamaño de los conductores de puesta a tierra, ubicación de la nidad de descarga de la antena, conexión a los electrodos de tierra, y requisitos para el electrodo de tierra.
 - 18. SERVICIO**

No intente reparar la unidad usted mismo; al abrir o retirar las cubiertas usted se expondrá a alta tensión y a otros peligros. Solicite todo servicio a personal calificado.
Ejemplo:
 - a. Cuando el cable de alimentación o la clavija estén dañados.
 - b. Si se ha derramado líquido sobre la unidad, o si algún objeto ha caído dentro del videograbador.
 - c. Si la unidad ha sido expuesta a la lluvia o al agua.
 - d. Cuando a pesar de haber seguido las instrucciones de operación, la unidad no funcione normalmente.
Ajuste solamente los controles indicados en el manual de instrucciones; el ajuste incorrecto de otros controles podrá causar daños a la unidad, la que por lo general requerirá de un prolongado trabajo de reparación (por un técnico calificado) para que sus condiciones normales de operación puedan ser restablecidas.
 - e. Si la unidad se ha caído o si el gabinete se ha dañado.
 - f. Cuando la unidad muestre un cambio notorio en su rendimiento.
 - 19. PIEZAS DE REPUESTO**

Cuando sea necesario reemplazar piezas, asegúrese de que el técnico de servicio emplee las piezas de repuesto especificadas por el fabricante, o piezas que tengan las mismas características que las piezas originales. Los cambios no autorizados podrán causar incendios, descargas eléctricas y otros problemas.
 - 20. REVISION DE SEGURIDAD**

Al finalizar cualquier servicio de mantenimiento o reparación de esta unidad, solicítele al técnico que efectúe comprobaciones de seguridad para determinar si el videograbador se encuentra o no en condiciones óptimas de operación.
 - 21. CALOR**

El producto debe ser situado lejos de fuente de calor como radiadores, reguladores de calefacción, estufas o otros productos (incluyendo amplificadores) que se producen calor.
 - 22. BANDEJA DEL DISCO**

No acerque sus dedos a la bandeja del disco cuando se está cerrando. Puede recibir heridas graves.
 - 23. CONEXION**

Cuando conecte el producto a otro equipo, desconecte la alimentación y desenchufe todos los equipos del tomacorriente. Si no lo hace, puede provocar una descarga eléctrica y heridas graves.
Lea cuidadosamente el manual de instrucciones del otro equipo y respete las instrucciones al hacer las conexiones.
 - 24. RAYO LASER**

No mire por la ranura de la bandeja del disco por las salidas de circulación de aire del producto para ver la fuente del rayo láser. Puede dañar sus ojos.
 - 25. DISCO**

No utilice un disco rayado, deformado o reparado. Estos discos se pueden romper fácilmente y provocar serias heridas o averías en el producto.
 - 26. NOTA PARA LA PERSONA QUE INSTALE EL SISTEMA CATV**





Se ha incluido este recordatorio para llamar la atención de quien instale el sistema CATV, con respecto al Artículo 820-40 de la NEC, que entrega directivas de guía para realizar una conexión adecuada a tierra y, en particular, especifica que el cable de puesta a tierra debe ser conectado al sistema de conexión a tierra del edificio, lo más cerca del punto de entrada del cable como sea posible.
- ## CONDENSACION
- Se condensará humedad en la sección de funcionamiento del DVD/VCR si se lo trae de un lugar fresco a una habitación caliente o si la temperatura en la habitación sube repentinamente. En este caso, se verán afectadas las prestaciones del DVD/VCR. Para evitarlo, deje el DVD/VCR a la nueva temperatura durante aproximadamente una hora antes de conectarlo, o haga que la temperatura en la habitación suba gradualmente.
También puede condensarse humedad durante el verano si el DVD/VCR está expuesta a una corriente de aire del acondicionador de aire. En estos casos, cambie el lugar donde está instalado el DVD/VCR.

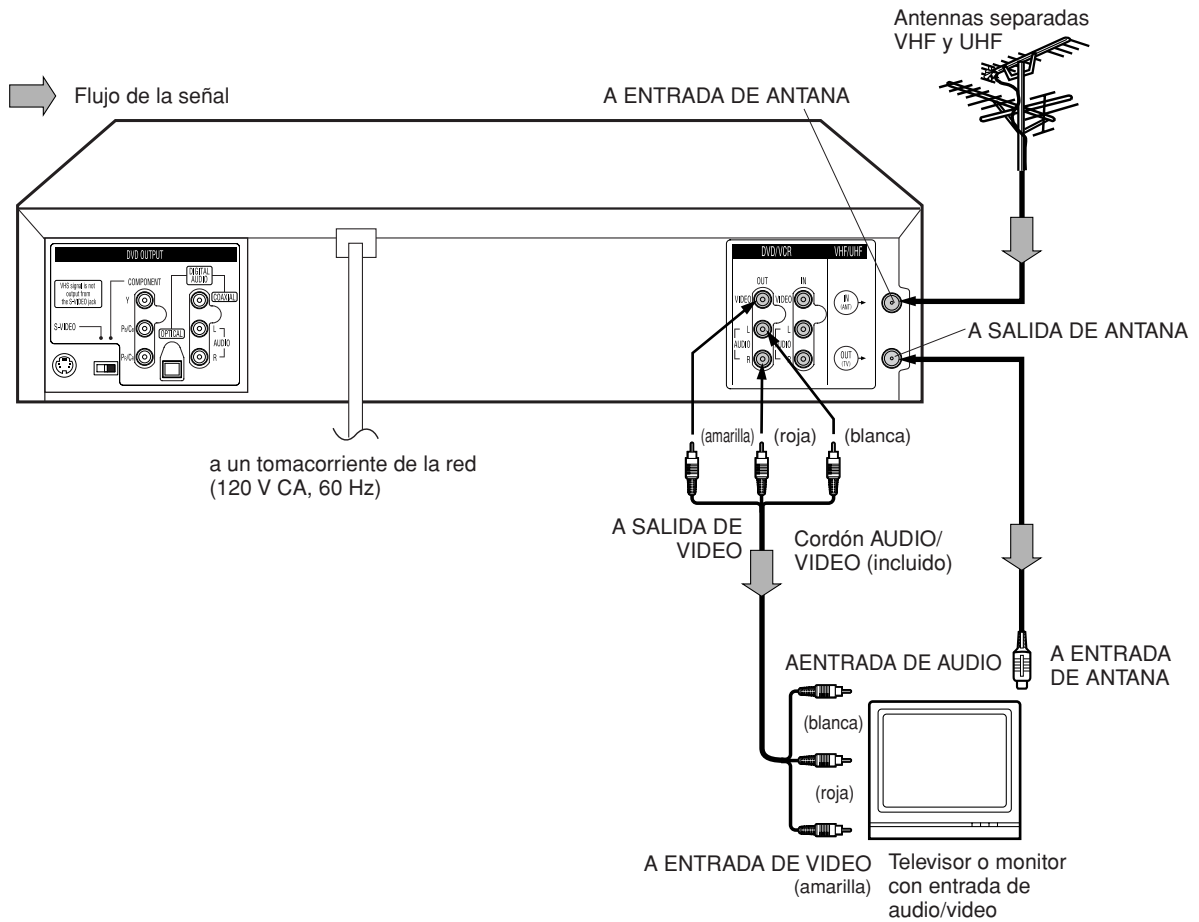



Conexión a un televisor



Ajuste del canal de video

- Mantenga presionado **3** o **4** durante 3 segundos en el mode desconectado para seleccionar CH 3 o 4.
 El número del canal seleccionado parpadeará en la pantalla durante 3 segundos.
- Presione **POWER** para encender el DVD/VCR.

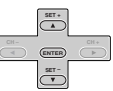
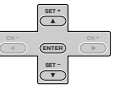
- Presione **VCR DVD** para seleccionar el modo VCR.
 El indicador VCR del panel frontal se iluminará.
- Encienda el televisor y ajústelo al canal 3 o 4, en correspondencia con el canal seleccionado en el paso 1.
- Presione **TV/VCR** para seleccionar la posición VCR.
 El indicador VCR se iluminará.
- Presione el botón selector de canal en + o - (CH + / -) para recibir una estación de TV de su área. El número de canal aparecerá en la pantalla durante unos 4 segundos.



Selección de idioma en pantalla

- Presione **VCR MENU**. Presione **SET + o -** para seleccionar la opción "SYSTEM SETUP", luego presione **ENTER**.
 Si utiliza la unidad por primera vez y presiona **VCR MENU**, es posible que aparezca la pantalla de menú SYSTEM SETUP en lugar de la pantalla del menú principal.
- Presione **SET + o -** para seleccionar el modo LANGUAGE, luego presione **ENTER**.

- Presione **SET + o -** para seleccionar el idioma deseada: inglés (ENGLISH), español (ESPAÑOL) o francés (FRANCAIS), luego presione **ENTER**.

- Presione **VCR MENU** para volver a la imagen normal de TV.









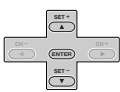
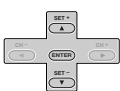
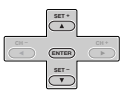

Ajuste de reloj automatico

- 1 Conecte la antena o sistema de cable.
 - Si utiliza una caja de cable, enciéndala.
- 2 Enchufe el cable eléctrico de CA a un tomacorriente CA.
- 3 Compruebe que el DVD/VCR está apagado.
 - Si presiona **POWER**, el ajuste automático no se activará.
- 4 Espere por lo menos tres minutos y presione **POWER**.
 
- 5 Presione **CALL** para verificar el reloj en la pantalla.
 
- 6 Si el reloj no ha quedado ajustado, verifique el estado de la antena. El reloj automático no funciona en el estado de recepción.

Ajuste de reloj manual

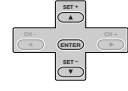

- 1 Presione **VCR MENU**.
 
- 2 Presione **SET + o -** para seleccionar la opción "SYSTEM SETUP", luego presione **ENTER**.
 
- 3 Presione **SET + o -** para seleccionar la opción "CLOCK SET", luego presione **ENTER**.
 
- 4 Presione el botón **SET + o -** para establecer el mes, y a continuación presione el botón **ENTER**.
 
- 5 Ajuste el día, año y hora de acuerdo con el procedimiento del paso 4.
- 6 Una vez ajustado el reloj, la fecha y la hora empiezan a funcionar automáticamente.

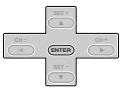
Selección de TV/CATV

- 1 Presione **VCR MENU**.
 
 Presione **SET + o -** para seleccionar la opción "CH SETUP", luego presione **ENTER**.
 
- 2 Presione **SET + o -** para seleccionar el modo "TV/CATV".
 
- 3 Presione **ENTER** para seleccionar el modo TV o CATV. La flecha indica el modo seleccionado.
 

TV - Canales de VHF/UHF
 CATV - Canales de TV CABLE
- 4 Presione **VCR MENU** para volver a la imagen normal de TV.
 

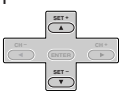
Ajuste automático de los canales

- 1 Repita el paso 1 descrito arriba y presione **SET + o -** para seleccionar la opción "AUTO CH MEMORY".
 
- 2 Luego presione **ENTER**.
 
 Empieza la sintonización automática. La indicación de canal irá subiendo y cuando termina, la pantalla vuelve a su estado normal.

Borrado de un canal de la memoria

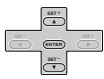
- 1 Repita el paso 1 descrito arriba y presione **SET + o -** para seleccionar la opción "ADD/DELETE", luego presione **ENTER**.
 
- 2 **Para añadir o borrar los canales deseados**
 - 1 Presione los **botones de número** o **SET + o -** para seleccionar un número de canal que desee añadir o borrar.
 - 2 **Para añadir canales**
 Presione **ENTER** hasta que aparezca "ADD" en la pantalla para añadir el canal sin memorizar.
Para borrar canales
 Presione **ENTER** hasta que aparezca "DELETE" en la pantalla para borrar el canal de la memoria. El número del canal parpadeará.
- 3 Repita de **1** a **2** para añadir o borrar otro canal.





Reproducción

1 Coloque una cinta pregrabada. (Cuando se carga una cinta de cassette sin la lengüeta de prevención de borrado, la reproducción comenzará automáticamente.)

2 PARA INICIAR LA REPRODUCCION



Presione **PLAY**. La reproducción comenzará. "▶" aparecerá en pantalla durante 4 segundos aproximadamente.

PARA INTERRUPIR REPRODUCCION



Presione **STOP** (PARADA) una vez. La cinta parará, pero permanecerá cargada y lista para reproducir. "■" aparecerá en pantalla durante 4 segundos aproximadamente.

Rebobinado o avance rápido de la cinta

Detenga la reproducción o la grabación mediante **STOP**.

Para rebobinar la cinta:



Presione **REW**.

Para avanzar la cinta:



Presione **FWD**.

Para detener el bobinado de la cinta, presione **STOP**. Para pasar directamente a reproducción (sin presionar **STOP**), presione **PLAY**.

Modo de búsqueda de imagen hacia adelante/atrás

Mientras se bobina la cinta, puede pasar al modo de búsqueda de imagen. Para ello, presione **REW** o **FWD** y manténgalo presionado. La unidad volverá a bobinar la cinta en cuanto se suelte el botón.

Búsqueda de imagen

Función de búsqueda de imagen hacia atrás

Presione **REW** una o dos veces durante la reproducción.



Función de búsqueda de imagen hacia adelante

Presione **FWD** una o dos veces durante la reproducción. Para volver a la reproducción: Presione **PLAY**.



Imagen fija

Presione **PAUSE/STILL** durante la reproducción. Para continuar la reproducción normal: Presione **PLAY** o **PAUSE/STILL**.

PAUSE/STILL



Camara lenta

Durante la reproducción presione **SLOW**. Para volver a la reproducción: Presione **PLAY** o **SLOW**.

SLOW



Avance cuadro a cuadro

Presione **PAUSE/STILL** durante la reproducción. Presione **SLOW** repetidamente: La imagen avanza cuadro a cuadro.

Para volver a la reproducción: Presione **PLAY** o **PAUSE/STILL**.

PAUSE/STILL



SLOW



Grabacion de un programa de TV

1 Coloque un cassette en el cual la lengüeta de protección contra borrados accidentales esté intacta. El DVD/VCR se encenderá automáticamente.

2 Presione **SP/SLP** para seleccionar la velocidad de cinta deseada SP o SLP.

**SP/SLP
PLAY MODE**



El contador y "SP" o "SLP" se aparecerá en la pantalla durante 4 segundos aproximadamente.

3 Ajuste la opción TV/CATV en la posición apropiada.

**TV - Canales de VHF/UHF
CATV - Canales de TV CABLE**

4 Presione los botones de selección directa de canal para seleccionar el canal o **CH +/-** a grabar:

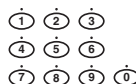

Selección directa de canal en modo de TV:

Todos los canales podrán ser seleccionados en forma instantánea usando sólo dos botones. (Por ejemplo, para seleccionar el canal 2, presione "0" y "2". Si usted sólo presiona "2", la selección del canal se retardará dos segundos.) Para los canales de 10 en adelante, presione los dos dígitos en orden.

Selección directa de canal en modo de CATV:

1-9 Presione **0** dos veces y luego 1 al 9 como se requiera. Ej.: para seleccionar 2, presione "002".
10-12 Presione primero el **0** y luego los 2 dígitos restantes en el orden de izquierda a derecha. Ej.: presione **012** para "12".
13-99 Presione 2 dígitos en orden. Ej.: presione **22** para "22".
100-125 Presione 3 dígitos en orden. Ej.: Presione **110** para "110".

5 Presione el botón **REC**.

REC/OTR



"●" aparecerá en la pantalla durante 4 segundos aproximadamente. El indicador "REC" aparecerá en pantalla.

6 Presione el botón de parada **STOP** para detener la grabación.

STOP



"■" aparecerá en pantalla durante 4 segundos aproximadamente.



Grabacion por temporizador

- 1** Presione **VCR MENU**. Seleccione la opción **TIMER REC SET** y presione **ENTER**.

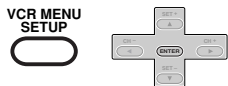

- 2** Presione **SET + o -** para seleccionar el N° de programa, luego presione **ENTER**.

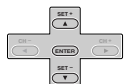

- 3** Presione **SET + o -** para seleccionar la fecha deseada, luego presione **ENTER**.



- 4** Ajuste el tiempo de partida, tiempo de término, canal y velocidad de cinta como en paso 3.

- 5** Para fijar otros programas, repita los pasos 2 al 4 para fija el otro programas.



- Para volver a la pantalla normal, presione dos veces **VCR MENU**.

- 6** Presione **TIMER REC**. El símbolo de reloj (🕒) aparecerá en el visualizador y el VCR quedará en modo de espera para grabación.



Al mismo tiempo, el modo VCR cambiará automáticamente a modo DVD. Es posible utilizar el DVD incluso cuando el VCR está en modo de grabación por temporizador. Si no utiliza el DVD, apáguelo.

Grabacion por temporizador de un solo toque (OTR)

- 1** Coloque un cassette con la lengüeta de protección contra borrados accidentales esté intacta.
El DVD/VCR se encenderá automáticamente.

- 2** Presione **SP/SLP** para seleccionar la velocidad de la cinta deseada SP o SLP.
El contador y "SP" o "SLP" aparecerán en pantalla durante 4 segundos aproximadamente.



- 3** Ajuste la opción TV/CATV en la posición apropiada.

TV - Canales de VHF/UHF
CATV - Canales de TV CABLE

- 4** Presione el botones de selección de canales directos o botón **CH +/-** para seleccionar el canal a ser grabado.

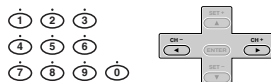

- 5** Presione **OTR** para comenzar la grabación. Presione el botón nuevamente para detener la grabación después de 30 minutos. Cada presión de **OTR** aumentará el tiempo de grabación hasta un máximo de 6 horas. OTR y el tiempo de grabación aparecerá en pantalla durante 4 segundos. Y "●" aparecerá en el visualizador.



Presione	Tiempo de Grabac.	Presione	Tiempo de Grabac.
Una vez	GRABAC. NORMAL	6 veces	3:00
2 veces	0:30	7 veces	4:00
3 veces	1:00	8 veces	5:00
4 veces	1:30	9 veces	6:00
5 veces	2:00	10 veces	GRABAC. NORMAL

Para cancelar OTR

Presione **STOP (PARADA)** para apagar la energía. "■" aparecerá en pantalla durante 4 segundos aproximadamente.

Si desea ver la reproducción del DVD durante el OTR o grabación estándar, presione **VCR DVD** para cambiar al modo DVD y reproducir el DVD.



Reproducción básica (DVD)

Preparación:

- ENCIENDA el TV y ajústelo en el modo de entrada de video.
- Presione **VCR DVD** para seleccionar el modo DVD. (El indicador DVD se iluminará.)

- 1** Presione **OPEN/CLOSE** en el aparato.
Se abrirá la bandeja del disco.



- 2** Coloque un disco en la bandeja. Sujete el disco, colóquelo con el lado de etiqueta impresa hacia arriba, alinee en las guías y coloque el disco en su posición correcta.

- 3** Presione **PLAY** o **OPEN/CLOSE** en el aparato. La bandeja del disco se cierra automáticamente. En la pantalla del TV la indicación "▶" cambia a "▶" y empieza la reproducción.

- Aparece la pantalla del menú en la pantalla de TV, si el disco tiene una función de menú. En este caso, presione **▶**, **◀**, **◂**, **▸** ó **ENTER** para activar una función de menú.



- 4** Presione **STOP** para terminar la reproducción.
- El aparato graba el punto de parada, según el disco. Aparece "■" en la pantalla. Presione **PLAY** para continuar reproduciendo (desde el mismo punto).
 - Si presiona nuevamente **STOP** o se retira el disco (Aparece "■" en la pantalla), el aparato borrará el punto de parada.



- 5** Para la reproducción, presione **STOP**. A continuación presione **OPEN/CLOSE** en el aparato. Se abre la bandeja del disco. Saque el disco y presione **OPEN/CLOSE** en el aparato y presione **POWER (I/O)**. La bandeja del disco se cierra automáticamente y se desconecta el aparato.



Reproducción con avance rápido

- Presione **FWD** durante la reproducción normal. Cada vez que presione el botón de **FWD**, aumentará la velocidad de la búsqueda.
- Para seguir con la reproducción normal, presione **PLAY**.



Reproducción con retroceso rápido

- Presione **REW** durante la reproducción normal. Cada vez que presione el botón de **REW**, aumentará la velocidad de la búsqueda.
- Para seguir con la reproducción normal, presione **PLAY**.

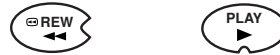

Reproducción Fija

- Presione **PAUSE/STILL** durante la reproducción normal para hacer una pausa en la reproducción.
- Para seguir con la reproducción normal, presione **PLAY**.



Avance cuadro por cuadro

- Presione **PAUSE/STILL** durante la imagen fija. Avanza un cuadro cuando presione **PAUSE/STILL** una vez.
- Para seguir con la reproducción normal, presione **PLAY**.



Reproducción de cámara lenta

- Presione **SLOW** durante la reproducción normal o cuadro a cuadro. Cada vez que presione el botón de **SLOW**, cambiará la velocidad del slow.
- Para seguir con la reproducción normal, presione **PLAY**.
 - Para volver a la imagen fija, presione **PAUSE/STILL**.





Búsqueda de un capítulo o canción

Pulse **SKIP** o varias veces para visualizar el capítulo o la pista que desee.

La reproducción se inicia desde el capítulo o la pista que haya seleccionado.



Para localizar capítulos o pistas subsiguientes.



La reproducción se inicia desde el principio del capítulo o pista actual. Si se pulsa dos veces, la reproducción se inicia desde el principio del capítulo o pista anterior.

Funciones básicas del control remoto

- Presione **POWER** () para encender o apagar el DVD/VCR.
- Seleccione su modo operativo deseado (DVD o VCR) utilizando **VCR DVD**. El indicador DVD o VCR del panel frontal le mostrará qué modo está seleccionado.
- Presione **CH +** o **CH -** para desplazarse por los canales uno a la vez.
- **CH +/-** (/) y **SET +/-** (/) se utilizan también para navegar por el sistema de menús en pantalla.
- Los **botones de número** permiten acceder directamente a canales concretos.
- Cada vez que se presiona **VCR DVD** en el control remoto, la pantalla alterna entre la pantalla VCR (modo VCR) y la pantalla DVD (modo DVD).

Funcionamiento

- Apunte el mando a distancia al sensor remoto y presione los botones de control para hacer funcionar.
- Utilice el control remoto dentro de un ángulo de 30° hacia ambos lados del sensor remoto, hasta una distancia de unos 7 metros.

Coloque las pilas

- 1 Deslice la tapa del compartimento de las pilas siguiendo la dirección de la flecha.

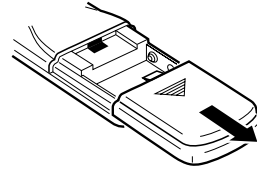

- 2 Coloque dos pilas "AAA", (suministradas) prestando atención a las marcas de polaridad en el compartimiento de las pilas.

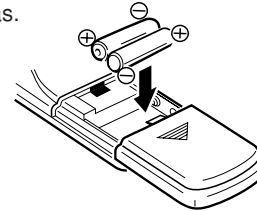

- 3 Recoloque la tapa del compartimiento.

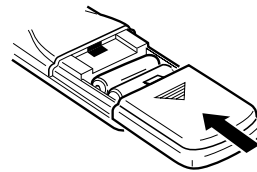

Notas sobre los derechos de autor

La ley prohíbe copiar, difundir, mostrar, emitir por cable, reproducir en público, y alquilar sin permiso material con derechos de autor reservados (copyright).

Este dispositivo no graba en cinta DVDs protegidos contra copias. El dispositivo no ha de utilizarse para copiar contenidos bajo Copyright sin el permiso expreso por escrito del propietario de los derechos de autor.

La obtención de tal permiso es responsabilidad exclusiva del usuario.

Este producto incorpora la tecnología de protección de derechos de autor (Copyright) mediante un método que protege ciertas patentes de EE.UU. y otros derechos de propiedad intelectual pertenecientes a Macrovision Corporation y otros propietarios de derechos. La utilización de esta tecnología de protección deberá ser autorizada por Macrovision Corporation, y tiene como fin la utilización en el hogar y otros usos de contemplación limitados a menos que Macrovision Corporation autorice otra cosa. Está prohibido modificar esta ingeniería y desmontar la unidad.

Fabricado bajo licencia de Dolby Laboratories.
"Dolby", "Pro Logic" y el símbolo de la doble D son marcas comerciales de Dolby Laboratories.